

As of January 2022, all prices are subject to 13% increase.

Kotai Mario Ruiz, 2015/2021

Structure made of solid wood profile from European oaks. Tabletop made of solid wood from European oaks with 21 mm/0.83" of section. Also available in European oak veneer. Delivered unassembled.

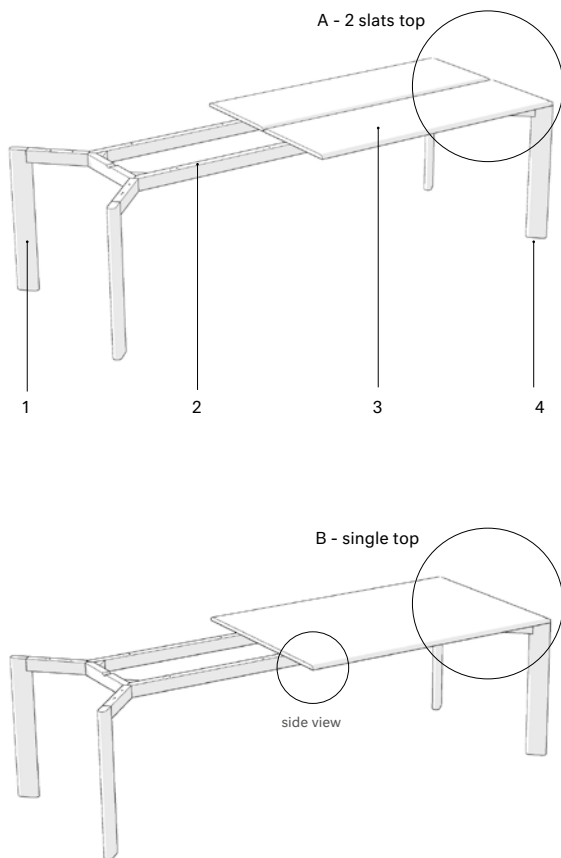

- 1 Legs made of solid wood profile from European oaks.
- 2 Structure made of solid wood profile from European oaks.
- 3 Tabletop options:
 - 2 slats solid wood top 21 mm/0.83" thick.
 - single veneered top 21 mm/0.83".
- 4 Injected PA spacers.



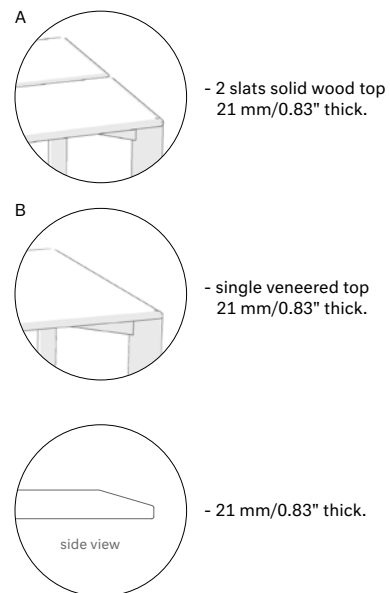





Tabletop options:



As of January 2022, all prices are subject to 13% increase.

Ref.	Article	Options	Total (CAD\$)	
			veneered top	solid wood
T457 Rectangular dining table				
			single top	2 slats top
T457 180	 <p>180x100x75 70.75" x 39.25" x 29.5"</p>	 <p>44 kg — 52 kg / 0,27 m³</p>	\$6,287	\$6,798
			single top	2 slats top
T457 200	 <p>200x100x75 78.75" x 39.25" x 29.5"</p>	 <p>49 kg — 57 kg / 0,30 m³</p>	\$6,564	\$7,046
			single top	2 slats top
T457 220	 <p>220x100x75 86.5" x 39.25" x 29.5"</p>	 <p>54 kg — 62 kg / 0,33 m³</p>	\$6,887	\$7,316
			single top	2 slats top
T457 240	 <p>240x100x75 94.5" x 39.25" x 29.5"</p>	 <p>59 kg — 67 kg / 0,36 m³</p>	\$7,841	\$8,072
			single top	2 slats top
T457 260	 <p>260x100x75 102.25" x 39.25" x 29.5"</p>	 <p>64 kg — 72 kg / 0,38 m³</p>	\$7,696	\$8,253

As of January 2022, all prices are subject to 13% increase.

Ref.	Article	Options	Total (CAD\$)	
			veneered top	solid wood
T456 Square dining table				
			single top	single top
T456 100	 <p>100x100x75 39.25" x 39.25" x 29.5"</p>	 27 kg —  33 kg / 0,15 m ³	\$4,970	\$5,818
			single top	single top
T456 120	 <p>120x120x75 47.25" x 47.25" x 29.5"</p>	 40 kg —  46 kg / 0,22 m ³	\$5,409	\$6,171
			single top	2 slats top
T456 140	 <p>140x140x75 55" x 55" x 29.5"</p>	 52 kg —  59 kg / 0,29 m ³	\$7,135	\$8,392

As of January 2022, all prices are subject to 13% increase.

Ref.	Article	Options	Total (CAD\$)	
			veneered top	solid wood
T455 Round dining table				
			single top	single top
T455 100	 <p>Ø100x75 Ø 39.25" x 29.5"</p>	 <p>21 kg – 27 kg / 0,15 m³</p>	\$4,963	\$5,594
			single top	single top
T455 120	 <p>Ø120x75 Ø 47.25" x 29.5"</p>	 <p>32 kg – 39 kg / 0,22 m³</p>	\$5,389	\$6,013
			single top	2 slats top
T455 140	 <p>Ø140x75 Ø 55" x 29.5"</p>	 <p>45 kg – 52 kg / 0,29 m³</p>	\$7,115	\$8,082

As of January 2022, all prices are subject to 13% increase.

Ref.	Article	Options	Total (CAD\$)
------	---------	---------	---------------

T460 Rectangular expandable dining table



veneered top



190x100x75
74.75" x 39.25" x 29.5"



240x100x75
94.5" x 39.25" x 29.5"







290x100x75
114.25" x 39.25" x 29.5"

88 kg — 105,5 kg / 0,29 m³



single top

\$10,355

As of January 2022, all prices are subject to 13% increase.

Ref.	Article	Options	Total (CAD\$)	
			veneered top	solid wood
T477 Rectangular high dining table				
			single top	2 slats top
T477 180	 180x100x90 70.75" x 39.25" x 35.5"	 47 kg —  55 kg / 0,27 m ³	\$6,563	\$7,075
			single top	2 slats top
T477 200	 200x100x90 78.75" x 39.25" x 35.5"	 52 kg —  60 kg / 0,30 m ³	\$6,841	\$7,323
			single top	2 slats top
T477 220	 220x100x90 86.5" x 39.25" x 35.5"	 57 kg —  65 kg / 0,33 m ³	\$7,164	\$7,593
			single top	2 slats top
T477 240	 240x100x90 94.5" x 39.25" x 35.5"	 62 kg —  70 kg / 0,36 m ³	\$7,758	\$8,349
			single top	2 slats top
T477 260	 260x100x90 102.25" x 39.25" x 35.5"	 67 kg —  75 kg / 0,38 m ³	\$7,973	\$8,531

As of January 2022, all prices are subject to 13% increase.

Ref.	Article	Options	Total (CAD\$)	
			veneered top	solid wood
T480 Desk				
T480 120	 <p>120x50x75 47.25" x 19.75" x 29.5"</p>	<p>📦 25 kg — 📦 29 kg / 0,15 m³</p>	\$3,399	\$3,557
T480 150	 <p>150x50x75 59" x 19.75" x 29.5"</p>	<p>📦 29 kg — 📦 33 kg / 0,18 m³ — 📖 177</p>	\$3,795	\$3,927
T480 180	 <p>180x50x75 70.75" x 19.75" x 29.5"</p>	<p>📦 33 kg — 📦 37 kg / 0,22 m³</p>	\$4,158	\$3,307



Tusch Seating International Inc.
251 Bartley Dr. Unit #4
Toronto, ON M4A 2N7 Canada
www.tuschseating.co

T 416.368.6100
F 416.368.4477
T 888.368.6101
info@tuschseating.com