

Prices shown are not the final selling price.  
To obtain the list price, multiply the price by 2.65.  
Prices effective as June 2019.

# BEND

— By Stone Designs —

**TS** Tusch  
Seating  
International



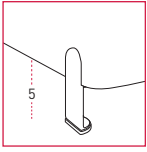

Steel Legs

**BEND MODULES - SERIE 10** Without Backrest

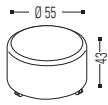
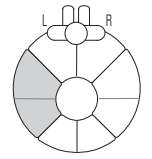
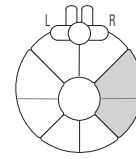
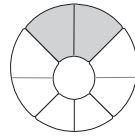
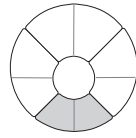

**F10**  
 Rounded Module  
 Ø55cm Diameter

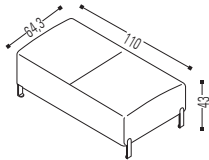

**F21**  
 Straight module  
 110x64 cm

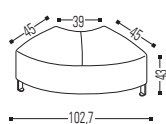

**F22**  
 Curved Symetric Module  
 45 cm Side

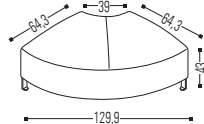

**F23**  
 Curved Symetric Module  
 64 cm Side

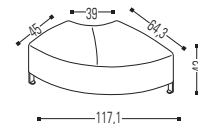

**F24**  
 Non Symetric Curved Module  
 Right

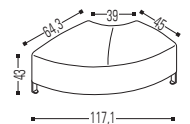

**F25**  
 Non Symetric Curved  
 Module Left

**BEND MODULES - SERIE 10** With Backrest

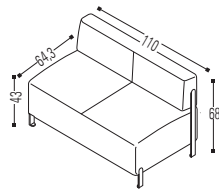

**F31**  
 Straight module  
 110x64 cm  
 With Backrest

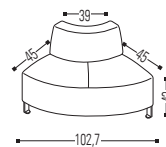

**F32**  
 Curved Symetric Module  
 45 cm Side  
 With Backrest

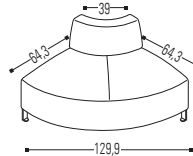

**F33**  
 Curved Symetric Module  
 64 cm Side  
 With Backrest

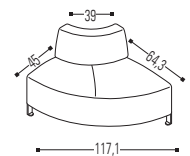

**F34**  
 Non Symetric Curved  
 Module Right  
 With Backrest

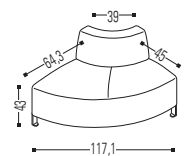

**F35**  
 Non Symetric Curved  
 Module Left  
 With Backrest

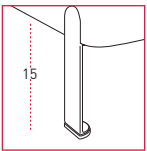

Steel Legs

**BEND MODULES - SERIE 20** Without Backrest

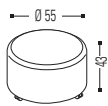

**F10**  
 Rounded Module  
 Ø55 cmDiameter

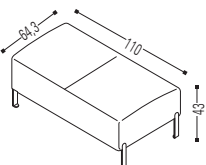

**F41**  
 Straight module  
 110x64 cm

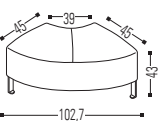

**F42**  
 Curved Symetric Module  
 45 cm Side

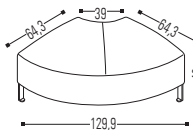

**F17"**  
 Curved Symetric Module  
 64 cm Side

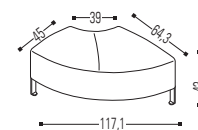

**F44**  
 Non Symetric Curved  
 Module Right

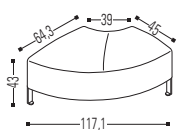

**F45**  
 Non Symetric Curved  
 Module Left

**BEND MODULES - SERIE 20** With Backrest

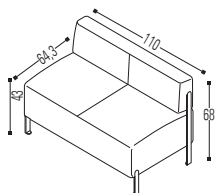

**F51**  
 Straight module  
 110x64 cm  
 With Backrest

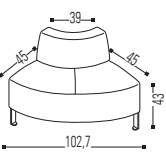

**F52**  
 Curved Symetric Module  
 45 cm Side  
 With Backrest

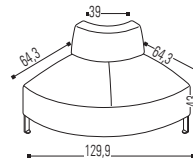

**F53**  
 Curved Symetric Module  
 64 cm Side  
 With Backrest

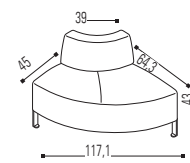

**F54**  
 Non Symetric Curved  
 Module Right  
 With Backrest

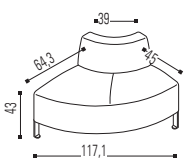

**F55**  
 Non Symetric Curved  
 Module Left  
 With Backrest

Prices shown are not the final selling price.  
 To obtain the list price, multiply the price by 2.65.  
 Prices effective as June 2019.

## Bend Program

FEATURES **BEND**

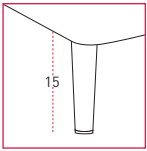

Wood Legs

### BEND MODULES - SERIE 30 Without Backrest

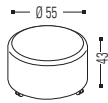
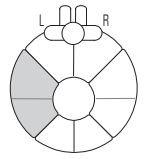
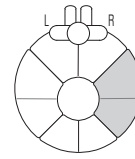
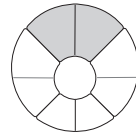
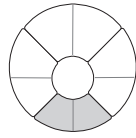

**F10**  
 Rounded Module  
 Ø55 cm Diameter

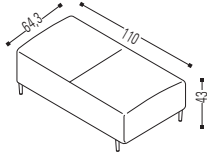

**F61**  
 Straight module  
 110x64 cm

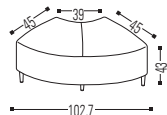

**F62**  
 Curved Symetric Module  
 45 cm Side

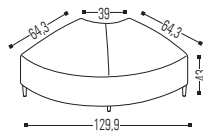

**F63**  
 Curved Symetric Module  
 64 cm Side

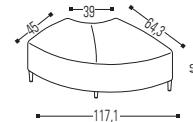

**F64**  
 Non Symetric Curved  
 Module Right

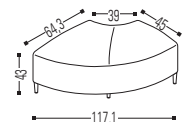

**F65**  
 Non Symetric Curved  
 Module Left

### BEND ACCESSORIES AUXILIARY TABLES

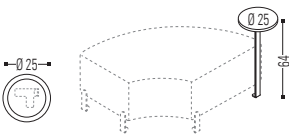

--PD

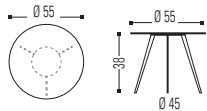

FM55

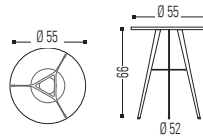

FM15

## FINISHES

### Group 1: Fabric T - Newport

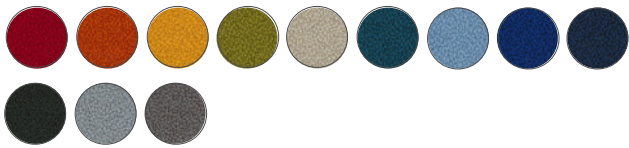

### Group 4: Fabric M - Melang & Step

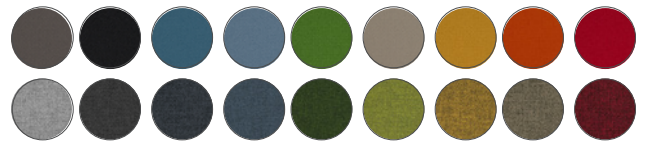

### Group 3: Fabric V - Valencia

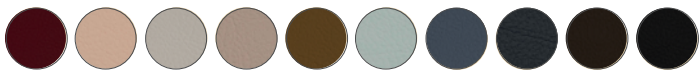





### Group 7: Fabric A - Synergy



### Group 3: Fabric D - Felicity



**TABLE OF FINISHES**

	GROUP 1	GROUP 3	GROUP 4	GROUP 7
	FABRIC T	FABRIC V	FABRIC D	FABRIC M
				
FABRIC	T--	V--	D--	M--

**HOW TO ORDER A BEND MODEL WITHOUT BACKREST**

To place an order for a product, the reference will be complemented with the desired finish code, replacing the 3 BLUE hypens with the desired tiles finish.

The available finishes are reflected in the price list.

Ej: F218--->> Module Bend 110x64,3x43 cm - 2 Seats - Withot Backrest - M19 Finish --> F218 M19

**F218 M19**

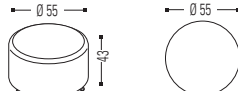
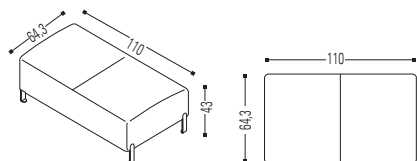
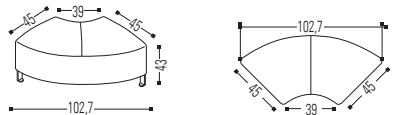
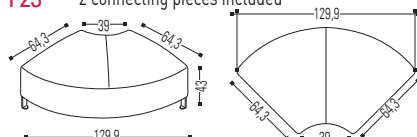
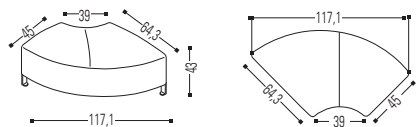
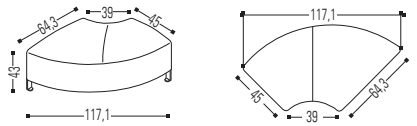

**BEND SERIE 10 - STEEL LEG (h=5cm) - MODULES WITHOUT BACKREST**

Model	Description	Support	References	GROUP 1	GROUP 3	GROUP 4	GROUP 7	Packaging Packs- Vol - Weight
<b>F10</b> 	Rounded Modul Ø55 cm Diameter	Levelers	F118---	337,40	354,20	362,60	404,60	
		Black Castors	F108---	337,40	354,20	362,60	404,60	
<b>F21</b> 2 connecting pieces included 	Straight module 110x64 cm	Black Legs	F218---	760,20	798,00	819,00	922,60	
<b>F22</b> 2 connecting pieces included 	Curved Regular Module 45 cm Side	Black Legs	F228---	548,80	578,20	590,80	644,00	
<b>F23</b> 2 connecting pieces included 	Curved Regular Module 64 cm Side	Black Legs	F238---	718,20	760,20	778,40	859,60	
<b>F24</b> 2 connecting pieces included 	Irregular Curved Module Right	Black Legs	F248---	648,20	674,80	693,00	767,20	
<b>F25</b> 2 connecting pieces included 	Irregular Curved Module Left	Black Legs	F258---	648,20	674,80	693,00	767,20	

**HOW TO ORDER MODULE BEND WITH AUXILIARY WRITING TABLE**

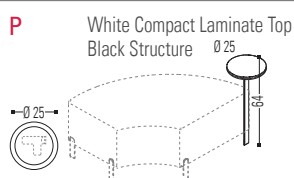

All **BEND** modules are offered with standard legs. To order modules with **Auxiliary Writing Table** ( Right hand - PD), always sitting position on the larger radius larger, the Bend module code has to be completed with the corresponding finish of the writing table requested indicating it before the fabric finish. Price should be increased as indicated below:

- Increase for Auxiliary Writing Table - Right Hand (PD): + 107,80

Example: **AUXILIARY WRITING TABLE (PD)**: Bend model: F218\_M15 + Auxiliary Writing Table-Right Hand: PD = F218 107,80 + 819,00 = 926,80  
PD M15

**BEND - AUXILIARY CASTORS - ONLY FOR BEND-SERIE 10 MODELS**

Model	Description	Finish	References	PVP Pack	Packaging Packs- Vol - Weight
<b>FM68</b> 	Black 37 mm diameter castors with Teflon tyre thread PACK 5 CASTORS	Black	FM68	18,20	

**TABLE OF FINISHES**

	GROUP 1	GROUP 3	GROUP 4	GROUP 7
	FABRIC T	FABRIC V	FABRIC D	FABRIC M
FABRIC	BACKREST T--	V--	D--	M--
	SEAT T--	V--	D--	M--

**HOW TO ORDER A BEND MODEL WITHOUT BACKREST**

To place an order for a product, the reference will be complemented with the desired finish code, replacing the 3 BLUE hypens with the desired tiles finish. The available finishes are reflected in the price list.

Ej: F318----->> Module Bend 110x64,3x43 cm - 2 Seats in M15 Melange Fabric - With Backrest in M91 Melange Fabric --> F318 M15M91

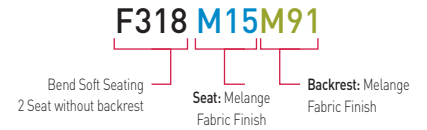

**BEND SERIE 10 - STEEL LEG (h=5cm) - MODULES WITH BACKREST**

Model	Description	Support	References	GROUP 1	GROUP 3	GROUP 4	GROUP 7	Packaging Packs· Vol · Weight
<b>F31</b> 2 connecting pieces included 	Straight module 110x64 cm With Backrest	Black Legs	F318-----	922,60	974,40	1.006,60	1.124,20	
<b>F32</b> 2 connecting pieces included 	Curved Regular Module 45 cm Side With Backrest	Black Legs	F328-----	740,60	779,80	798,00	883,40	
<b>F33</b> 2 connecting pieces included 	Curved Regular Module 64 cm Side With Backrest	Black Legs	F338-----	910,00	960,40	985,60	1.099,00	
<b>F34</b> 2 connecting pieces included 	Irregular Curved Module Right With Backrest	Black Legs	F348-----	840,00	876,40	900,20	1.006,60	
<b>F35</b> 2 connecting pieces included 	Irregular Curved Module Left With Backrest	Black Legs	F358-----	840,00	876,40	900,20	1.006,60	

**HOW TO ORDER MODULE BEND WITH AUXILIARY WRITING TABLE**

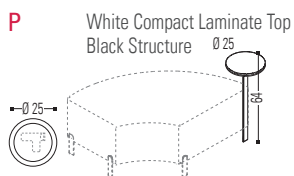

All **BEND** modules are offered with standard legs. To order modules with **Auxiliary Writing Table** ( Right hand - PD), always sitting position on the larger radius larger, the Bend module code has to be completed with the corresponding finish of the writing table requested indicating it before the fabric finish. Price should be increased as indicated below:





- Increase for Auxiliary Writing Table - Right Hand (PD): + 107,80

Example: **AUXILIARY WRITING TABLE (PD)**: Bend model: F218\_M15 + Auxiliary Writing Table-Right Hand: PD = F218 107,80 + 819,00 = 926,80  
PD M15

**BEND - AUXILIARY CASTORS - ONLY FOR BEND-SERIE 10 MODELS**

Model	Description	Finish	References	PVP Pack	Packaging Packs· Vol · Weight
<b>FM68</b> 	Black 37 mm diameter castors with Teflon tyre thread PACK 5 CASTORS	Black	FM68	107,80	

TABLE OF FINISHES

	GROUP 1	GROUP 3	GROUP 4	GROUP 7
	FABRIC T	FABRIC V	FABRIC D	FABRIC M
				
FABRIC	T--	V--	D--	M--

HOW TO ORDER A BEND MODEL WITHOUT BACKREST

To place an order for a product, the reference will be complemented with the desired finish code, replacing the 3 BLUE hypens with the desired tiles finish.

The available finishes are reflected in the price list.

Ej: **F418---** --> Module Bend 110x64,3x43 cm - 2 Seats - Withot Backrest - M19 Finish --> **F418 M19**

**F418 M19**

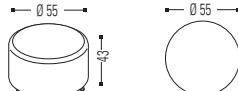
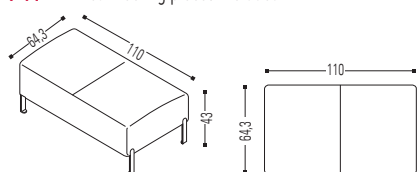
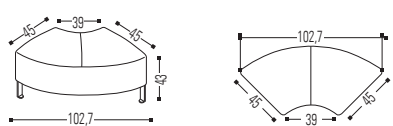
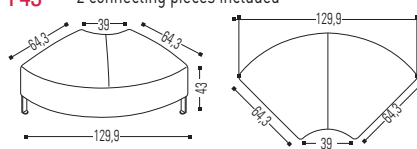
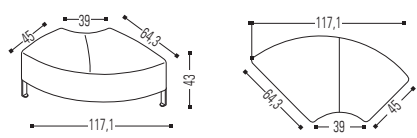
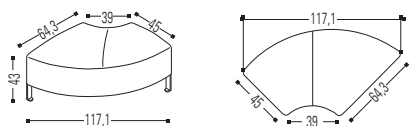

**BEND SERIE 20 - STEEL LEG (h=15cm) - MODULES WITHOUT BACKREST**

Model	Description	Support	References	GROUP 1	GROUP 3	GROUP 4	GROUP 7	Packaging Packs- Vol - Weight
<b>F10</b> 	Rounded Modul Ø55 cm Diameter	Levelers	<b>F118---</b>	337,40	354,20	362,60	404,60	
		Black Castors	<b>F108---</b>	337,40	354,20	362,60	404,60	
<b>F41</b> 2 connecting pieces included 	Straight module 110x64 cm	Black Legs	<b>F418---</b>	786,80	828,80	845,60	947,80	
<b>F42</b> 2 connecting pieces included 	Curved Regular Module 45 cm Side	Black Legs	<b>F428---</b>	574,00	606,20	616,00	669,20	
<b>F43</b> 2 connecting pieces included 	Curved Regular Module 64 cm Side	Black Legs	<b>F438---</b>	744,80	789,60	803,60	886,20	
<b>F44</b> 2 connecting pieces included 	Irregular Curved Module Right	Black Legs	<b>F448---</b>	673,40	705,60	718,20	793,80	
<b>F45</b> 2 connecting pieces included 	Irregular Curved Module Left	Black Legs	<b>F458---</b>	673,40	705,60	718,20	793,80	

HOW TO ORDER MODULE BEND WITH AUXILIARY WRITING TABLE

**P** Structure noire et plateau en compact blanc



All **BEND** modules are offered with standard legs. To order modules with **Auxiliary Writing Table** ( Right hand - **PD**), always sitting position on the larger radius larger, the Bend module code has to be completed with the corresponding finish of the writing table requested indicating it before the fabric finish. Price should be increased as indicated below:

- Increase for Auxiliary Writing Table - Right Hand (**PD**): + 107,80

Example: **AUXILIARY WRITING TABLE (PD)**: Bend model: F218\_M15 + Auxiliary Writing Table-Right Hand: PD = F218 107,80 + 819,00 = 926,80

**TABLE OF FINISHES**

	GROUP 1	GROUP 3		GROUP 4	GROUP 7	
	FABRIC T	FABRIC V	FABRIC D	FABRIC M	FABRIC A	
FABRIC	BACKREST T--	V--	D--	M--	A--	GROUP FABRIC B & S FINISHES WILL BE DISCONTINUED ONCE THE STOCKS FINISHED
	SEAT T--	V--	D--	M--	A--	

**HOW TO ORDER A BEND MODEL WITHOUT BACKREST**

To place an order for a product, the reference will be complemented with the desired finish code, replacing the 3 BLUE hypens with the desired tiles finish. The available finishes are reflected in the price list.

Ej: F518----->> Module Bend 110x64,3x43 cm - 2 Seats in M15 Melange Fabric - With Backrest in M91 Melange Fabric --> F518 M15M91

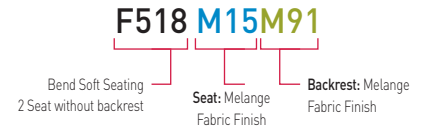

**BEND SERIE 20 - STEEL LEG (h=15cm) - MODULES WITH BACKREST**

Model	Description	Support	References	GROUP 1	GROUP 3	GROUP 4	GROUP 7	Packaging Packs- Vol - Weight
<b>F51</b> 2 connecting pieces included 	Straight module 110x64 cm With Backrest	Black Legs	F518-----	947,80	1.005,20	1.033,20	1.149,40	
<b>F52</b> 2 connecting pieces included 	Curved Regular Module 45 cm Side With Backrest	Black Legs	F528-----	765,80	809,20	824,60	908,60	
<b>F53</b> 2 connecting pieces included 	Curved Regular Module 64 cm Side With Backrest	Black Legs	F538-----	936,60	988,40	1.010,80	1.111,60	
<b>F54</b> 2 connecting pieces included 	Irregular Curved Module Right With Backrest	Black Legs	F548-----	865,20	908,60	926,80	1.033,20	
<b>F55</b> 2 connecting pieces included 	Irregular Curved Module Left With Backrest	Black Legs	F558-----	865,20	908,60	926,80	1.033,20	

**HOW TO ORDER MODULE BEND WITH AUXILIARY WRITING TABLE**





**P** Structure noire et plateau en compact blanc

All **BEND** modules are offered with standard legs. To order modules with **Auxiliary Writing Table** ( Right hand - **PD**), always sitting position on the larger radius larger, the Bend module code has to be completed with the corresponding finish of the writing table requested indicating it before the fabric finish. Price should be increased as indicated below:

- Increase for Auxiliary Writing Table - Right Hand (**PD**): + 107,80

Example: **AUXILIARY WRITING TABLE (PD)**: Bend model: F218\_M15 + Auxiliary Writing Table-Right Hand: PD = F218 107,80 + 819,00 = 926,80 PD M15

TABLE OF FINISHES

	GROUP 1	GROUP 3	GROUP 4	GROUP 7
	FABRIC T	FABRIC V	FABRIC D	FABRIC M
				
FABRIC	T--	V--	D--	M--

HOW TO ORDER A BEND MODEL WITHOUT BACKREST

To place an order for a product, the reference will be complemented with the desired finish code, replacing the 3 BLUE hypens with the desired tiles finish. The available finishes are reflected in the price list.

Ej: F618--- --> Module Bend 110x64,3x43 cm - 2 Seats - Withot Backrest - M19 Finish --> F618 M19

F618 M19

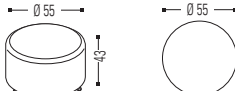
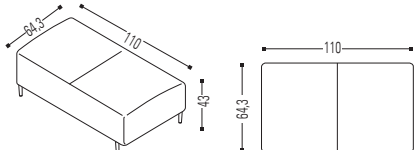
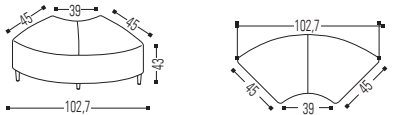
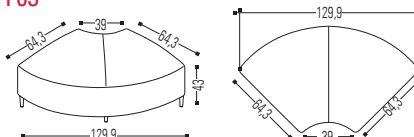
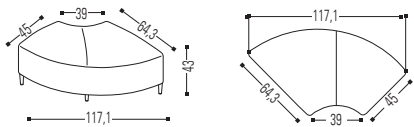
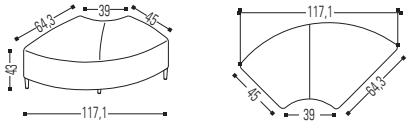

BEND SERIE 30 - WOOD LEG (h=15cm) - MODULES WITHOUT BACKREST

Model	Description	Support	References	GROUP 1	GROUP 3	GROUP 4	GROUP 7	Packaging Packs- Vol - Weight
<b>F10</b> 	Levelers	F118---		337,40	354,20	362,60	404,60	
	Black Castors	F108---		337,40	354,20	362,60	404,60	
<b>F61</b> 	Straight module 110x64 cm	Beech Lacquered Plywood	F618---	737,80	779,80	796,60	898,80	
<b>F62</b> 	Curved Regular Module 45 cm Side	Beech Lacquered Plywood	F628---	519,40	551,60	561,40	614,60	
<b>F63</b> 	Curved Regular Module 64 cm Side	Beech Lacquered Plywood	F638---	690,20	735,00	749,00	831,60	
<b>F64</b> 	Irregular Curved Module Right	Beech Lacquered Plywood	F648---	618,80	651,00	663,60	739,20	
<b>F65</b> 	Irregular Curved Module Left	Beech Lacquered Plywood	F658---	618,80	651,00	663,60	739,20	





Prices shown are not the final selling price.  
 To obtain the list price, multiply the price by 2.65.  
 Prices effective as June 2019.

**BEND**

ACCESSORIES FOR BEND

TABLE OF FINISHES

	WHITE	LIME OAK
		
MFC	00	11
C. LAMINATE	30	

HOW TO ORDER A AUXILIARY TABLE FOR BEND

To place an order for a product, the reference will be complemented with the desired finish code, replacing the 2 RED hypens with the desired tiles finish.

The available finishes are reflected in the price list.

Ej: **FM550---** --> bend Auxiliary Table - White Structure - White Compact Laminate Top --> **FM55030**

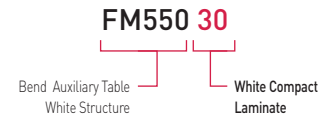

BEND - AUXILIARY TABLES

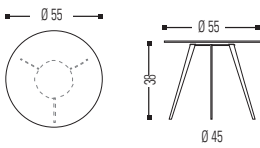
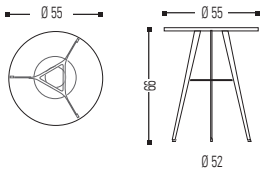
Model	Description	Structure	References	MFC	White C. Laminate	Packaging Packs- Vol - Weight
<b>FM55</b> 	Auxiliary coffee table.	White	<b>FM550--</b>	96,60	169,40	
		Black	<b>FM558--</b>	96,60	169,40	
<b>FM15</b> 	Auxiliary Table	White	<b>FM150--</b>	149,80	222,60	
		Black	<b>FM158--</b>	149,80	222,60	



**SEC-2U-B-9**

**Seclusion G2 Undermount Power Unit**

Contains Double USB, 2 Outlets, 9' Cord. Black or White  
 Mounts Under Metal Frame with 2 metal screws.

List

\$668