

Vogue

Manufacturer: Cierre1972 Italy

design_Stefano Conicconi

description

modular sofa with a metal frame supported by elastic belts. Seat cushion and backrest padded with expanded polyurethane foam, covered with siliconized microfiber. Wooden armrest frame padded with expanded polyurethane foam covered with siliconized microfiber. Unit legs made of black chrome-plated or polished chrome-plated metal.

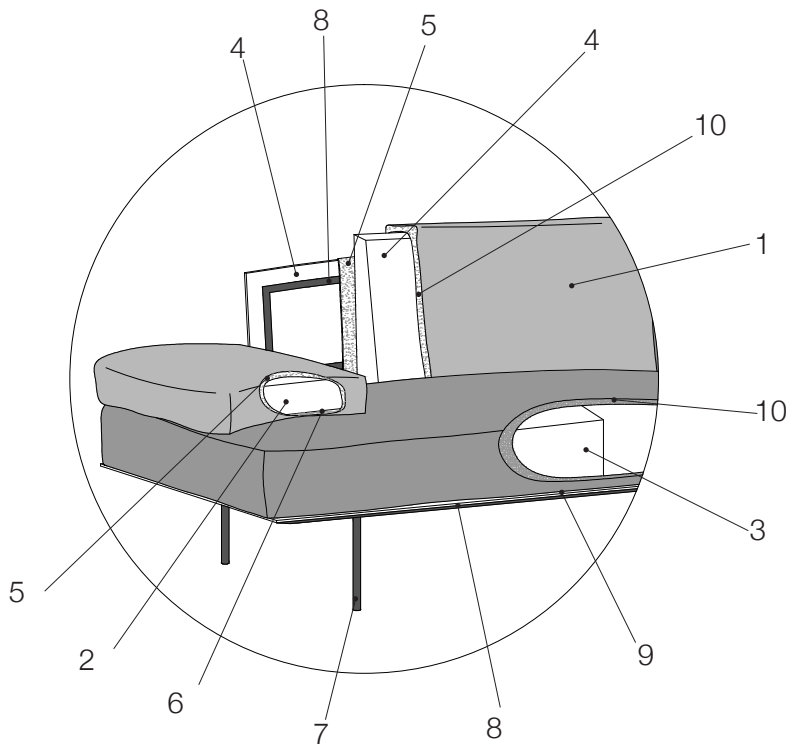

materials

1. cover
2. armrest cushions filling in expanded polyurethane foam with density 30 kg/m³
3. seat cushions filling in expanded polyurethane foam with different densities from 35 to 40 kg/m³
4. backrest cushions filling in polyurethane foam with different densities from 22 to 60 kg/m³
5. acrylic fiber padding
6. frame in multilayer poplar wood
7. polished or black chrome-plated metal legs
8. metal supporting frame
9. frame in medium density fiber board covered with Cuoio leather
10. siliconized microfiber padding

PRICE CALCULATION IN TWO MATERIALS

TO CALCULATE THE TOTAL PRICE OF A UNIT IN TWO MATERIALS, PLEASE SUM THE PRICES OF THE TWO COLUMNS: A + B

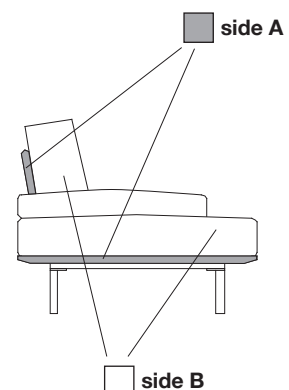

2_2 seats sofa

kg 85_volume 1,33 m³

	single	two materials	
		A	B
C.O.L. / C.O.M.	4.929 €	435 €	4.643 €
cat. 0	5.226 €	466 €	4.916 €
cat. 1	5.798 €	509 €	5.463 €
cat. 2	6.116 €	636 €	5.664 €

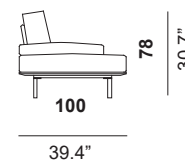
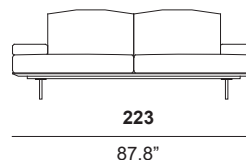

3_3 seats sofa

kg 95_volume 1,47 m³

	single	two materials	
		A	B
C.O.L. / C.O.M.	5.289 €	519 €	4.929 €
cat. 0	5.607 €	551 €	5.225 €
cat. 1	6.222 €	604 €	5.805 €
cat. 2	6.646 €	742 €	6.103 €

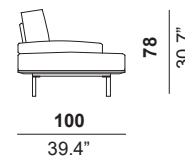
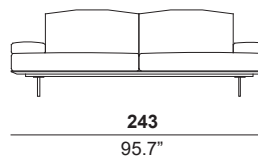

X_maxi sofa

kg 105_volume 1,59 m³

	single	two materials	
		A	B
C.O.L. / C.O.M.	5.713 €	519 €	5.366 €
cat. 0	6.053 €	551 €	5.683 €
cat. 1	6.720 €	604 €	6.318 €
cat. 2	7.197 €	742 €	6.672 €

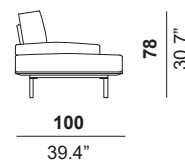
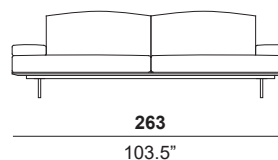

SX_extra large sofa

kg 120_volume 1,82 m³

	single	two materials	
		A	B
C.O.L. / C.O.M.	6.657 €	604 €	6.252 €
cat. 0	7.049 €	647 €	6.614 €
cat. 1	7.823 €	710 €	7.347 €
cat. 2	8.321 €	869 €	7.702 €

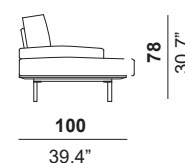
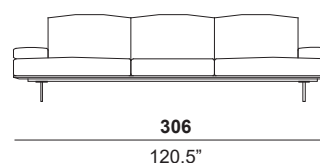

PRICE CALCULATION IN TWO MATERIALS: to calculate the total price of a unit in two materials, please sum the prices of the two columns: A + B

XG_Super maxi Sofa

kg 127_volume 1,85 m³

	single	two materials	
		A	B
C.O.L. / C.O.M.	6.922 €	604 €	6.525 €
cat. 0	7.335 €	647 €	6.909 €
cat. 1	8.141 €	710 €	7.674 €
cat. 2	8.660 €	869 €	8.051 €

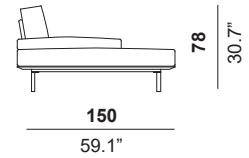
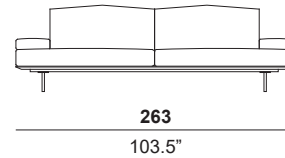

07_2 seats left arm | 08_2 seats right arm

kg 70_volume 1,2 m³

	single	two materials	
		A	B
C.O.L. / C.O.M.	4.505 €	435 €	4.206 €
cat. 0	4.770 €	466 €	4.447 €
cat. 1	5.300 €	509 €	4.950 €
cat. 2	5.565 €	636 €	5.096 €

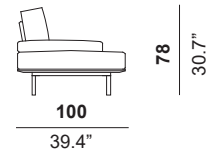
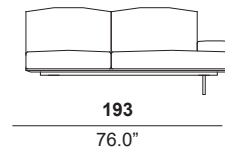
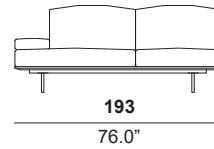

09_3 seats left arm | 10_3 seats right arm

kg 100_volume 1,67 m³

	single	two materials	
		A	B
C.O.L. / C.O.M.	6.233 €	604 €	5.815 €
cat. 0	6.593 €	647 €	6.145 €
cat. 1	7.325 €	710 €	6.834 €
cat. 2	7.770 €	869 €	7.134 €

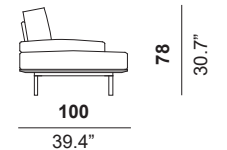
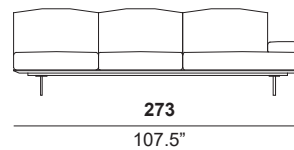
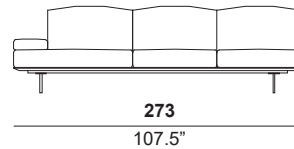

19_3 seats (2 cushions) left arm | 20_3 seats (2cushions) right arm

kg 80_volume 1,3 m³

	single	two materials	
		A	B
C.O.L. / C.O.M.	4.865 €	519 €	4.492 €
cat. 0	5.152 €	551 €	4.755 €
cat. 1	5.724 €	604 €	5.292 €
cat. 2	6.095 €	742 €	5.536 €

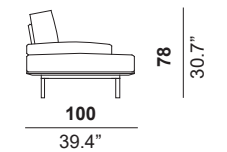
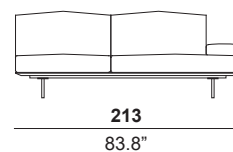
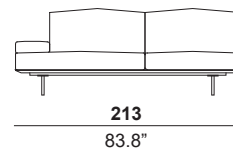

PRICE CALCULATION IN TWO MATERIALS: to calculate the total price of a unit in two materials, please sum the prices of the two columns: A + B.

29_maxi sofa (2 cushions) left arm | 30_maxi sofa (2 cushions) right arm

kg 92_volume 1,42 m³

	single	two materials	
		A	B
C.O.L. / C.O.M.	5.289 €	519 €	4.929 €
cat. 0	5.607 €	551 €	5.225 €
cat. 1	6.222 €	604 €	5.805 €
cat. 2	6.646 €	742 €	6.103 €

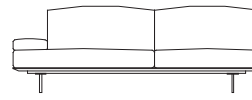

233

91.7"

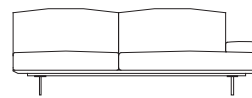

233

91.7"



100

39.4"

78
30.7"

15G_deep 1,5 seat left arm | 16G_deep 1,5 seat right arm

kg 70_volume 1,06 m³

	single	two materials	
		A	B
C.O.L. / C.O.M.	4.219 €	435 €	3.910 €
cat. 0	4.473 €	466 €	4.141 €
cat. 1	4.961 €	509 €	4.600 €
cat. 2	5.300 €	636 €	4.823 €

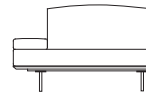

132

51.9"

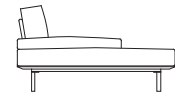

150

59.1"

78
30.7"

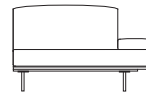

132

51.9"

77_armless 2 seat w. ottoman left side | 78_armless 2 seat w.ottoman right side

kg 85_volume 1,54 m³

	single	two materials	
		A	B
C.O.L. / C.O.M.	5.470 €	519 €	5.115 €
cat. 0	5.798 €	551 €	5.421 €
cat. 1	6.434 €	604 €	6.023 €
cat. 2	6.848 €	742 €	6.311 €

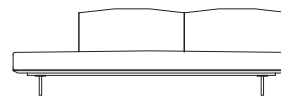

263

103.5"

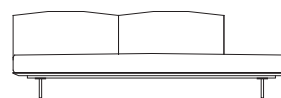

263

103.5"



100

39.4"

78
30.7"

TQ_square table

kg 16_volume 0,15 m³

	single
C.O.L. / C.O.M.	1.081 €
cat. 0	1.145 €
cat. 1	1.261 €
cat. 2	1.314 €

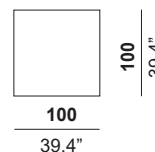

100

39.4"

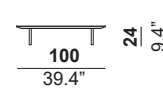

100

39.4"

24
9.4"

PRICE CALCULATION IN TWO MATERIALS: to calculate the total price of a unit in two materials, please sum the prices of the two columns: A + B

Vogue

Manufacturer: Cierre1972 Italy

TR_sofa rectang. side table

kg 10_volume 0,1 m³

	single
C.O.L. / C.O.M.	1.028 €
cat. 0	1.092 €
cat. 1	1.208 €
cat. 2	1.240 €



20+17

kg 147_volume 2,34 m³

	single
C.O.L. / C.O.M.	9.084 €
cat. 0	9.625 €
cat. 1	10.685 €
cat. 2	11.395 €

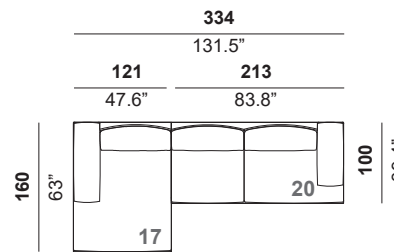

TR+78+TQ+30

kg 203_volume 3,21 m³

	single
C.O.L. / C.O.M.	12.868 €
cat. 0	13.642 €
cat. 1	15.126 €
cat. 2	16.048 €

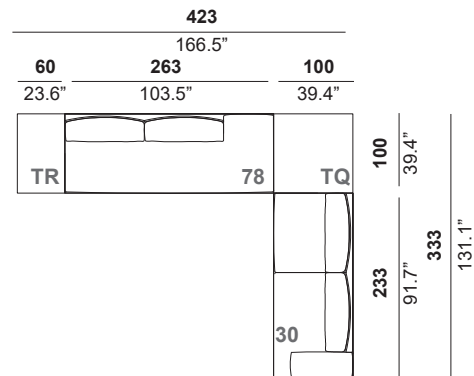

PRICE CALCULATION IN TWO MATERIALS: to calculate the total price of a unit in two materials, please sum the prices of the two columns: A + B

COM Orders are subject to following charges per manufacturer: \$22 per yard (any fabric) - Minimum: \$220.

COL Orders are subject to following charges per manufacturer: \$200 per leather hide.



Tusch Seating International Inc.

251 Bartley Dr. Unit #4
Toronto, ON M4A 2N7 Canada
www.tuschseating.com

T 416.368.6100

F 416.368.4477

T 888.368.6101

info@tuschseating.com