

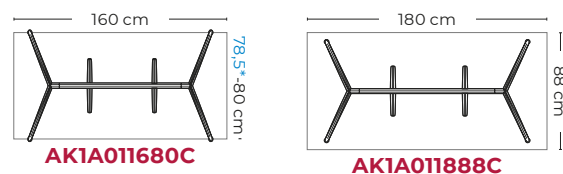
Prices shown are not the final selling price.
To obtain the list price, multiply the price by 2.65.
Prices effective as May 2025.

ARKITEK

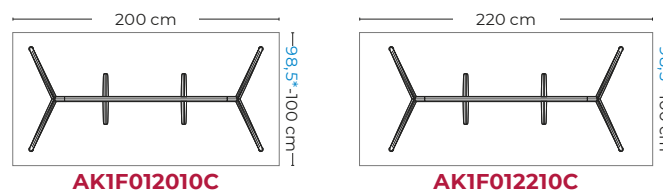


Table program

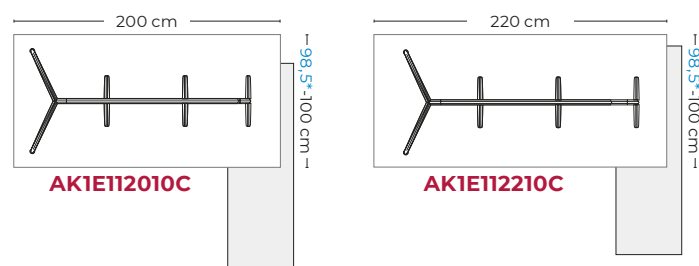
Individual operating tables and management · Width 80 / 88 cm



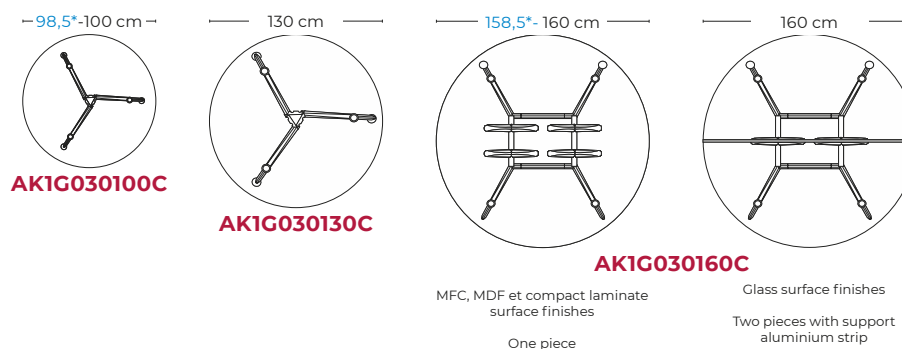
Management desks · Width 100 cm



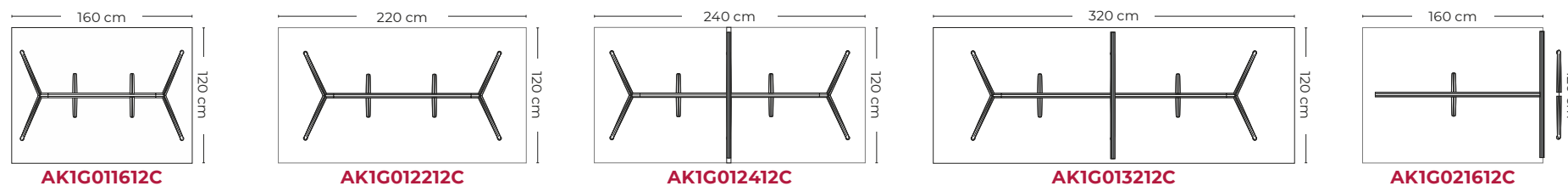
Tables with file support · Width 100 cm



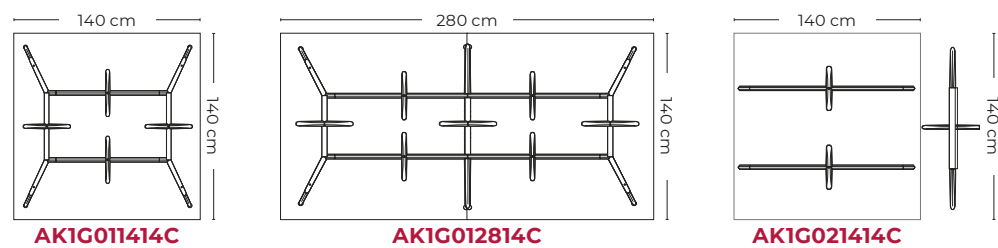
Meeting tables · Round



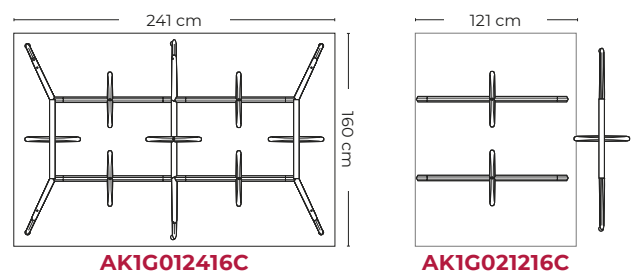
Meeting tables · Width 120 cm



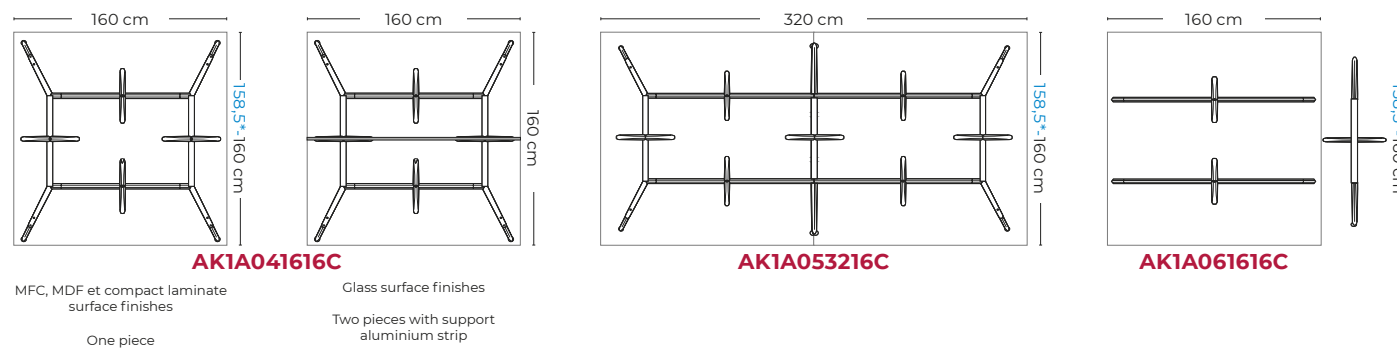
Meeting tables · Width 140 cm



Meeting tables · Width 160 cm



Double and meeting tables · Width 160 cm



*Measurements for surfaces in compact laminate finish.

Technical sheet

Individual tables



- 1 Surfaces in different finishes and colors.
- 2 Aluminum arms with support disc for glass surfaces.
- 3 Optional accessories hung on the table structure.
- 4 Aluminum structure in different finishes.
- 5 Aluminum levelers with anti-slip soleplate. Height 740,5 mm.

Multi-position tables



- 1 Surfaces in different finishes and colors.
- 2 Optional accessories placed on the table surface.
- 3 Aluminum arms with support disc for surfaces.
- 4 Suspended electrification trunking on the deck with access to wiring from the surface.
- 5 Aluminum structure in different finishes.
- 6 Aluminum levelers with anti-slip soleplate. Height 740,5 mm.

Surface finishes

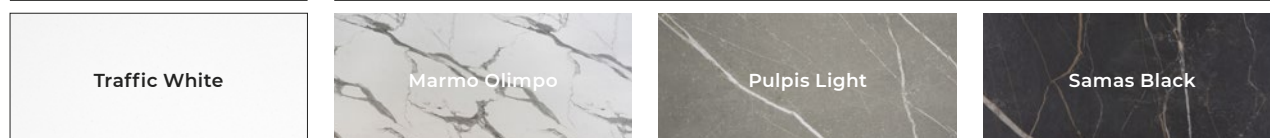
MFC · Thickness: 19 mm with straight edge



Compact Laminate · Thickness: 10 mm with chamfer edge

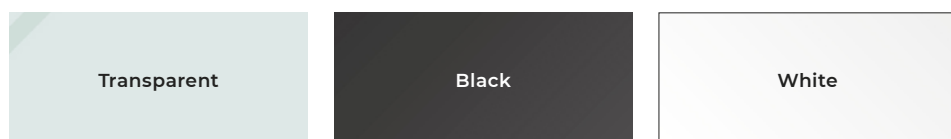
Black core

Coloured core



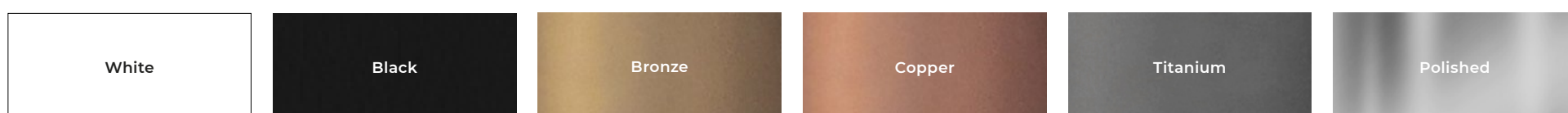
Laminated safety glass · 5 + 5 mm / 6 + 6 mm

Tempered glass · 10 mm



Structural finishes

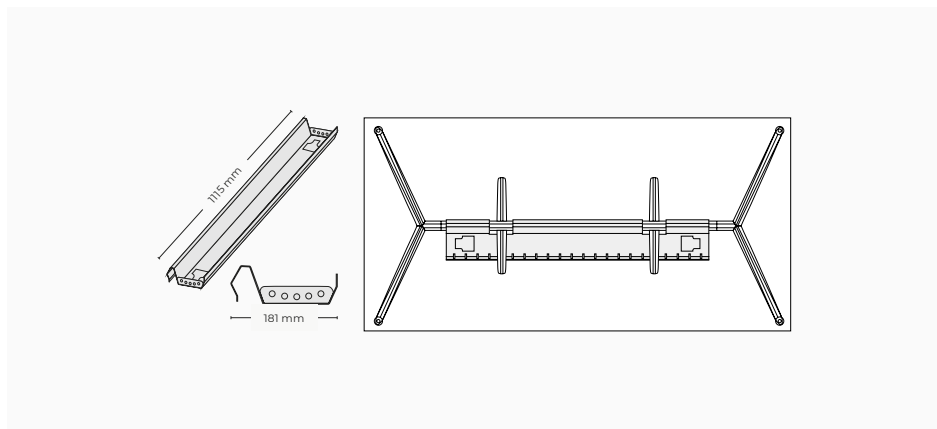
The legs are made of die-cast aluminum, while the crossbars are made of extruded aluminum. They are available in three finishes:



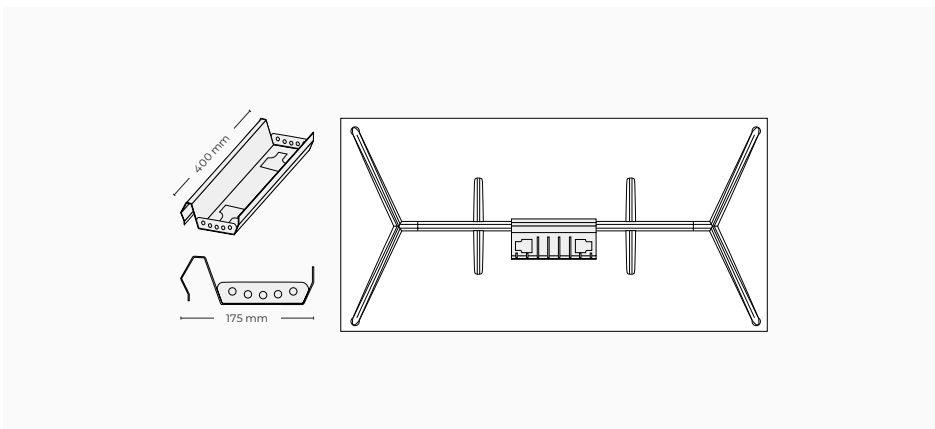
Optional accessories

Electrification systems

Lower metal channel with large capacity for wiring and connections. Provides maximum accessibility, optimizing the work surface, allowing optimal cable management.



Individual 1150 mm steel tray for individual 1800 and 200 cm tables.



Individual steel tray of 40 cm. for individual tables of 160, 180, 200 and 220 cm in length.

Ecodesign

Recycled materials	77,47%
Production	100%
Transport	100%
Use	Easy
Disposal	98,54%

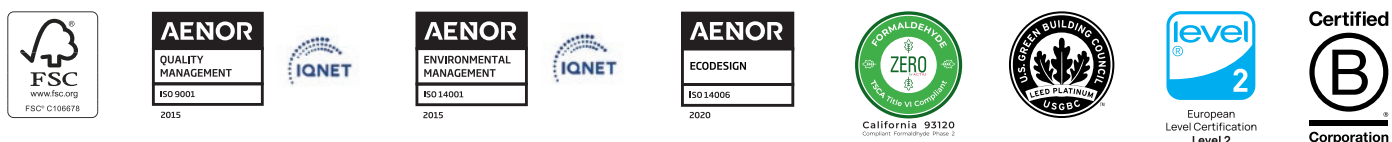
Recycled materials: Maximum use of materials to eliminate waste and minimize residues. Use of recyclable materials and recycled materials in components that do not affect functionality and durability. **Production:** Maximum optimization of energy use. Minimum environmental impact. State-of-the-art technological systems. Zero wastewater discharge. VOC-free coatings. Processes free of heavy metals, phosphates, OC and COD. **Transport:** Dismountable systems. Volumes that facilitate space optimization. Maximum reduction of energy consumption for transport. **Use:** Quality and guarantee. Long useful life. Possibility of substitution and replacement of elements. **Disposal:** Waste reduction. Reuse system of supplier-manufacturer packaging. Easy separation of components. Solvent-free water-based printing inks on packaging.

Standards

Prisma has passed the tests carried out in our laboratory and the tests performed at the Instituto Tecnológico del Mueble (AIDIMME) corresponding to the standards:

Regulations	Description
UNE-EN 527-1:2011	Office furniture. Work tables. Part 1: Dimensions.
UNE-EN 527-2:2017 + A1:2019	Office furniture. Work tables. Part 2: Requirements for safety, strength and durability.
UNE-EN 15372:2017	Furniture. Strength, durability and safety. Requirements for non-domestic tables.
REAL DECRETO RD 488/1997	

Certificates



Prices shown are not the final selling price.
To obtain the list price, multiply the price by 2.65.
Prices effective as May 2025.

How to code a reference



	Q Wiring Access	R Wiring Access	P Wiring Access	
	Maximum opening: 110°	Maximum opening: 180°	Maximum opening: 180°	
	<ul style="list-style-type: none"> Black die-cast aluminium frame Die-cast aluminium lid Aluminium guides for adjustment according to the thickness of the DESK-TOP FINISHES between 13 and 30 mm Dimensions: 30,5 x 12,1 cm 	<ul style="list-style-type: none"> Melamine lid of the same finish as the DESK-TOP FINISHES Black Bristle Brush Black die-cast aluminium frame Aluminium guides for adjustment according to the thickness of the DESK-TOP FINISHES between 13 and 30 mm Complete opening in 180° by means of hinges. Dimensions: 30,5 x 12,1 cm 	<ul style="list-style-type: none"> The wiring access P only includes the cut-out in the table top. If you order the desking with the optional PC wiring access, please refer to the accessories section to order the integrated power and data connection in the desk top. Compact solution for integrated power and data connection with easy workstation access. Different configuration combinations for a wide range of applications. Perimeter frame in black aluminium. Optional integrated aluminium cover to protect connections against dust and dirt. Available in black and white. Total dimensions: 241 x 73 mm Total dimensions cover: 257 x 87 mm Junction box top surface dimensions: 225 x 60 mm 	

-Models with this standard cable access has the icon next to the code
-Desk price with the cable access is as per the attached table.
-To order different desks which the electrification access is not standard, please check sales team.
-To order desks with cable access, please add the corresponding letter according to the desired placement, at the end of the reference:

WIRING ACCESS				
	FRONT CENTERED ACCESS	CENTERED ACCESS		
	QF RF	PC QC RC		

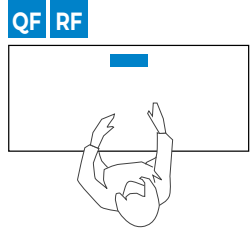
IMPORTANT NOTE:
The combination of WIRING access is carried out in the following way:
(If in any case you want the upper access in different finishing established, the customer must indicate it on the order.)

MELAMINE DESK-TOP FINISHES FINISHES AND STRUCTURE		COMBINATIONS OF FINISHES OFFERED			
DESK-TOP FINISHES	Structure	Q WIRING ACCES	R WIRING ACCES	P WIRING ACCES	
WHITE	WHITE	WHITE	WHITE	WHITE	
	BLACK	WHITE	WHITE	WHITE	
	BRONZE / COPPER / TITANIUM	WHITE	WHITE	WHITE	
	POLISHED	WHITE	WHITE	WHITE	
LIME OAK	WHITE	WHITE	LIME Oak	WHITE	
	BLACK	BLACK	LIME Oak	BLACK	
	BRONZE / COPPER / TITANIUM	BLACK	LIME Oak	BLACK	
	POLISHED	BLACK	LIME Oak	BLACK	
LIGHT OAK	WHITE	WHITE	LIGHT Oak	WHITE	
	BLACK	BLACK	LIGHT Oak	BLACK	
	BRONZE / COPPER / TITANIUM	BLACK	LIGHT Oak	BLACK	
	POLISHED	BLACK	LIGHT Oak	BLACK	
CHESTNUT	WHITE	WHITE	CHESTNUT	WHITE	
	BLACK	BLACK	CHESTNUT	BLACK	
	BRONZE / COPPER / TITANIUM	BLACK	CHESTNUT	BLACK	
	POLISHED	BLACK	CHESTNUT	BLACK	
DARK OAK	WHITE	BLACK	DARK Oak	BLACK	
	BLACK	BLACK	DARK Oak	BLACK	
	BRONZE / COPPER / TITANIUM	BLACK	DARK Oak	BLACK	
	POLISHED	BLACK	DARK Oak	BLACK	
BLACK	WHITE	BLACK	Black Anti.	BLACK	
	BLACK	BLACK	Black Anti.	BLACK	
	BRONZE / COPPER / TITANIUM	BLACK	Black Anti.	BLACK	
	POLISHED	BLACK	Black Anti.	BLACK	
MARMO OLIMPO	WHITE	WHITE	COMPACT LAMINATE - MARMO OLIMPO	WHITE	
	BLACK	WHITE	COMPACT LAMINATE - MARMO OLIMPO	WHITE	
	BRONZE / COPPER / TITANIUM	WHITE	COMPACT LAMINATE - MARMO OLIMPO	WHITE	
	POLISHED	WHITE	COMPACT LAMINATE - MARMO OLIMPO	WHITE	
PULPIS LIGHT	WHITE	WHITE	COMPACT LAMINATE - PULPIS LIGHT	WHITE	
	BLACK	BLACK	COMPACT LAMINATE - PULPIS LIGHT	BLACK	
	BRONZE / COPPER / TITANIUM	BLACK	COMPACT LAMINATE - PULPIS LIGHT	BLACK	
	POLISHED	BLACK	COMPACT LAMINATE - PULPIS LIGHT	BLACK	
SAMAS BLACK	WHITE	BLACK	COMPACT LAMINATE - SAMAS BLACK	BLACK	
	BLACK	BLACK	COMPACT LAMINATE - SAMAS BLACK	BLACK	
	BRONZE / COPPER / TITANIUM	BLACK	COMPACT LAMINATE - SAMAS BLACK	BLACK	
	POLISHED	BLACK	COMPACT LAMINATE - SAMAS BLACK	BLACK	

Superior cable access location to cabling and connections

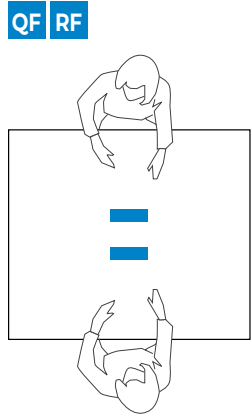
Rectangular desks - 80 cm wide

Front access

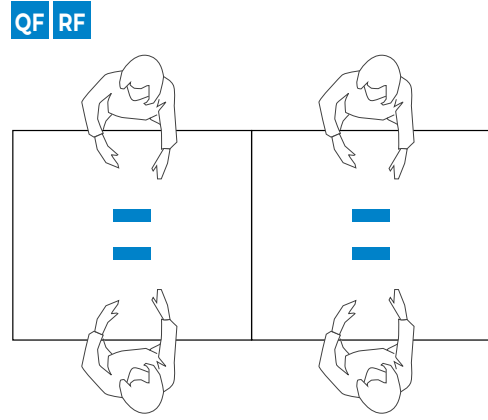


Twin and progressive desks - 160 cm wide

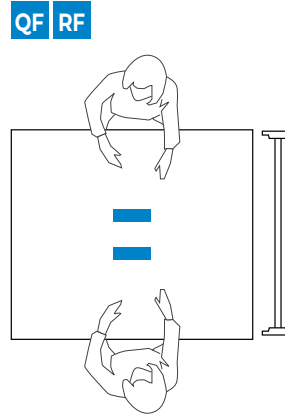
Front access



Front access

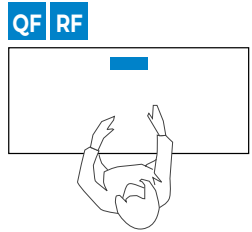


Front access

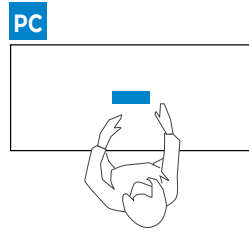


Executive and meeting desks - 100 cm wide

Front access

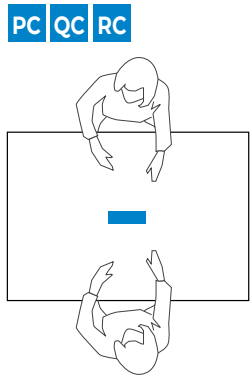


Centered access

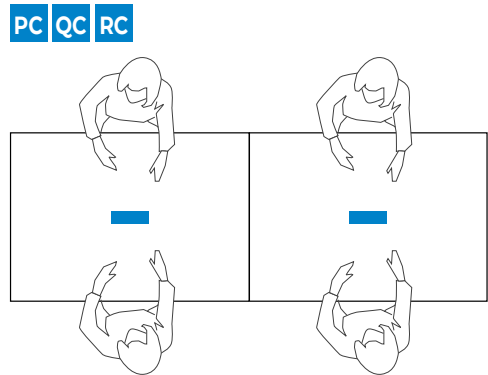


Meeting desks - 120 / 140 / 160 cm wide

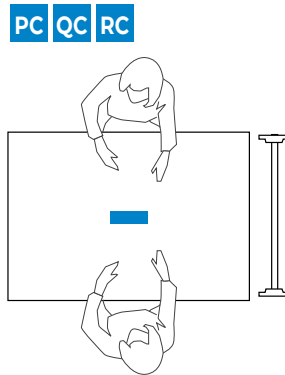
Centered access



Centered access

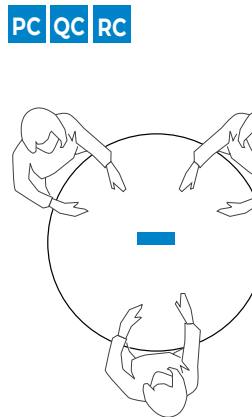


Centered access



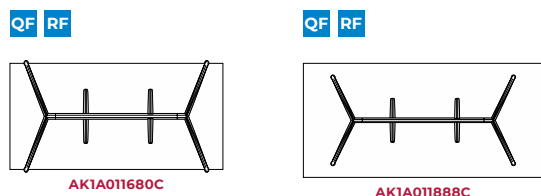
Meeting desks - 160 cm diameter

Centered access

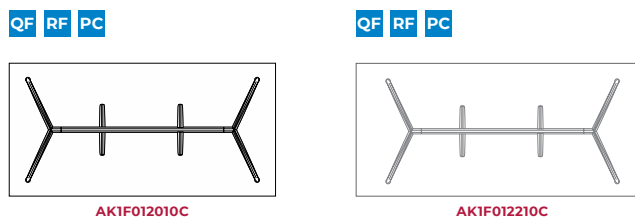


Program of tables

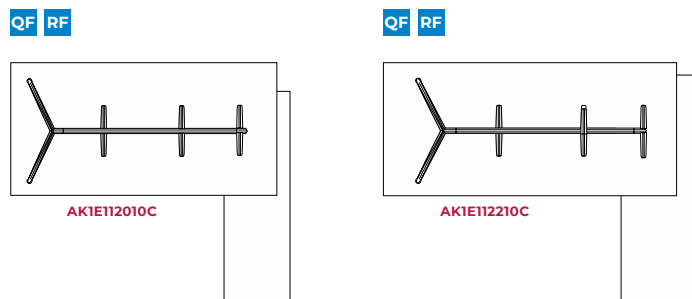
Individual operating tables · Width 800/88 cm



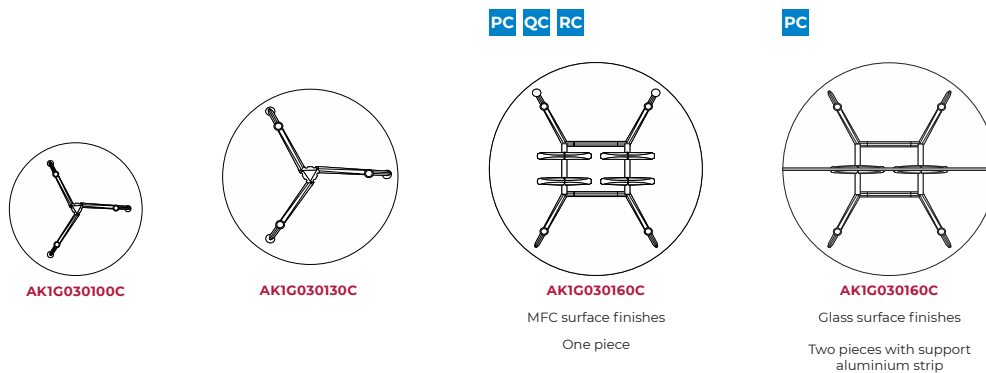
Meeting tables · Width 100 cm



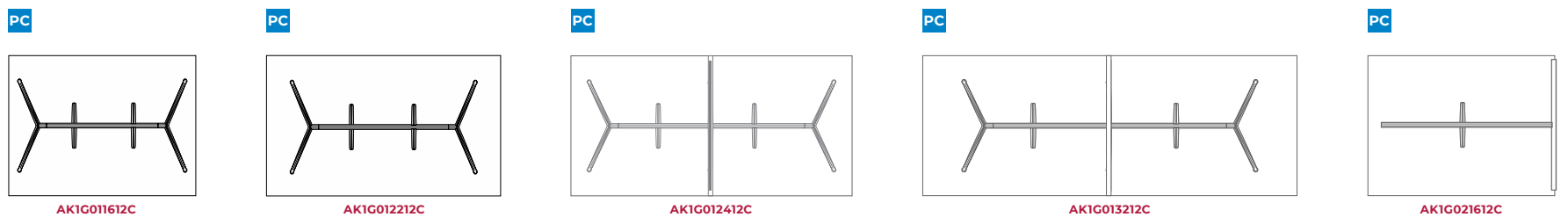
Tables with file support · Width 100 cm



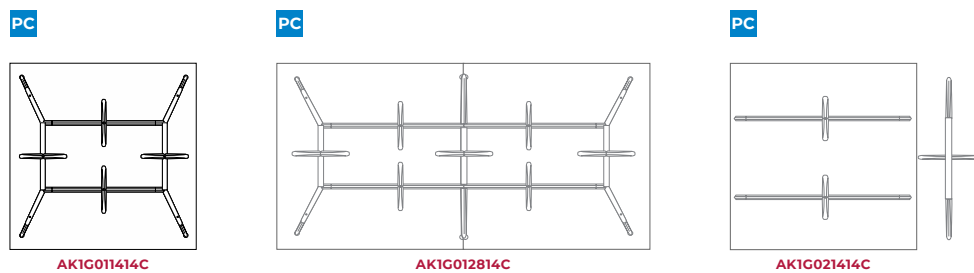
Meeting tables · Round



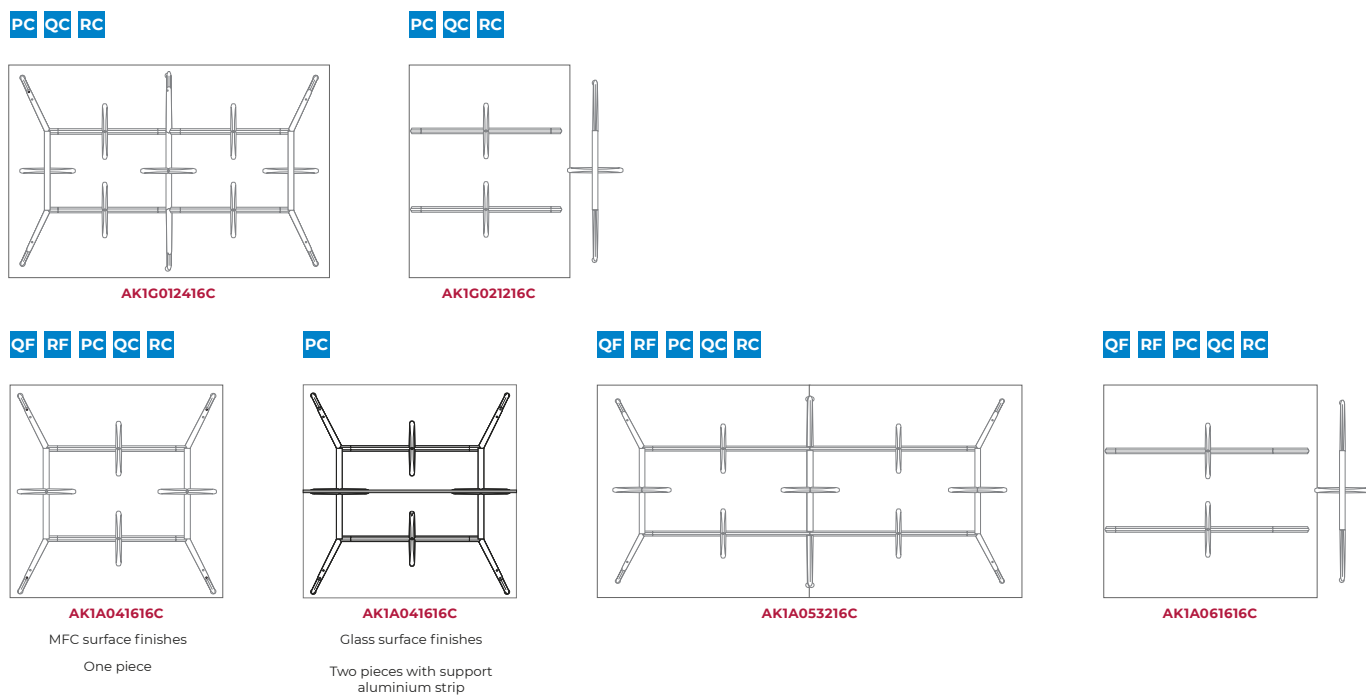
Meeting tables · Width 120 cm



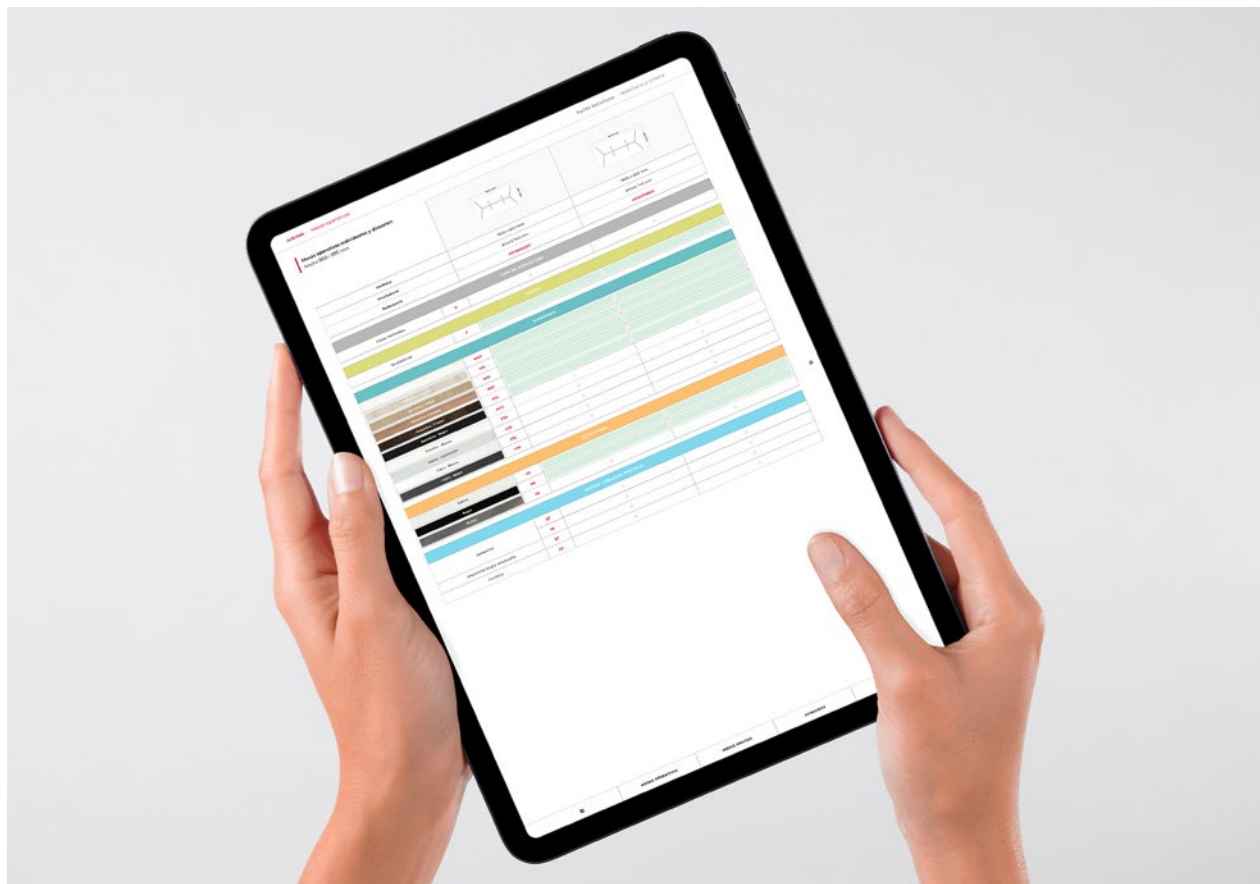
Meeting tables · Width 140 cm



Double, progression and meeting tables · Width 160 cm



How to code a reference



- 1 At the beginning of the coding and price tables of our price list, you will find the available models and their prices, as well as the basic reference of the product.
- 2 The system is designed to code vertically, adding desired components to the product by selecting the reference digits. Creating a correlation that will form the final order reference.
- 3 The finishes of arms, bases, optional complements, supports and upholstery will be shown in different colors so that the location of their reference and price is intuitive.
- 4 At the end of each table we will have legends or informative notes about the product being offered. Please read carefully to avoid confusion or mistakes when ordering.
- 5 This catalog has an interactive menu that will facilitate the user's navigation. It is located at the bottom of each page and from it you can go to the index, go back or even navigate within the family and the product displayed.

Example of reference configuration for an order

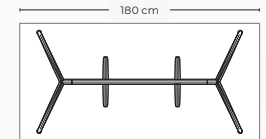
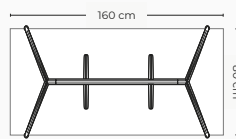
Arkitek · Individual tables & management	AK1
Straight individual tables	A01
Dimensions: 160 x 80 cm	1680
TYPE OF STRUCTURE ↓	
Angled legs	C
SUPPORT ↓	
Levelers	F
DESK-TOP FINISHES ↓	
MFC DESK-TOP FINISHES · White	M00
STRUCTURE ↓	
WHITE	00
WIRING ACCESS ↓	
MFC wiring access	QF
FINAL CONFIGURATION REFERENCE	
AK1 A01 1680C C F M00 00 QF	



* The final cost of the module will be obtained starting from the established base price and adding to it the cost of the different complements that are added to it.

	Configuration required to set up reference. No cost increase		Combination not available		Removed after stocks are exhausted
--	--	--	---------------------------	--	------------------------------------

Individual operating tables and direction
80 / 88 cm wide



Measures	160 x 80 cm	180 x 88 cm
Levelers	Height 74 cm	Height 74 cm
Reference	AK1A011680C	AK1A011888C

TYPE OF STRUCTURE			
Angled legs	C	1.009,40	1.036,00

SUPPORT			
Levelers	F		

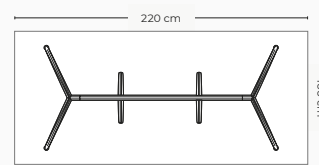
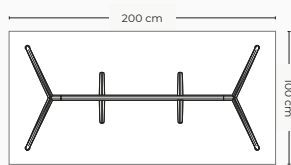
DESK-TOP FINISHES			
MFC · White	M00		
MFC · Lime Oak	M11		
MFC · Light Oak	M10		
MFC · Chestnut	M07		
MFC · Dark Oak	M14		
MDF · Black Anti-fingerprint	M03	+ 189,00	+ 189,00
Compact Laminate · Traffic White	F20	+ 460,60	+ 492,80
Compact Laminate · Samas Black	F28	+ 548,80	+ 588,00
Compact Laminate · Marmo Olimpo	F21	+ 859,60	+ 985,60
Compact Laminate · Pulpis Light	F26		
Glass · Transparent	V51	+ 600,60	+ 625,80
Glass · White	V52	+ 649,60	+ 782,60
Glass · Black	V59		

STRUCTURE			
White	00		
Black	08		
Bronze	35		
Copper	84	+ 50,40	+ 53,20
Titanium	12		
Polished	09	+ 428,40	+ 431,20

OPTIONAL WIRING ACCESS			
MFC / MDF · Black Anti-fingerprint / Compact Laminate	QF	+ 78,40	+ 78,40
MFC / MDF · Black Anti-fingerprint	RF	+ 100,80	+ 100,80
Compact Laminate	RF	+ 124,60	+ 124,60

Management desks and meeting tables

Width 100 cm



Measures	200 x 100 cm	220 x 100 cm
Levelers	Height 74 cm	Height 74 cm
Reference	AK1F012010C	AK1F012210C

TYPE OF STRUCTURE

Angled legs	C	1.087,80	1.146,60
-------------	----------	----------	----------

SUPPORT

Levelers	F		
----------	----------	--	--

DESK-TOP FINISHES

MFC · White	M00		
MFC · Lime Oak	M11		
MFC · Light Oak	M10		
MFC · Chestnut	M07		
MFC · Dark Oak	M14		
MFC · Black Anti-fingerprint	M03	+ 280,00	+ 287,00
Compact Laminate · Traffic White	F20	+ 574,00	+ 590,80
Compact Laminate · Samas Black	F28	+ 858,20	+ 987,00
Compact Laminate · Marmo Olimpo	F21	+ 1.351,00	+ 1.677,20
Compact Laminate · Pulpis Light	F26		
Glass · Transparent	V51	+ 697,20	
Glass · White	V52	+ 938,00	
Glass · Black	V59	+ 938,00	+ 966,00

STRUCTURE

White	00		
Black	08		
Bronze	35	+ 54,60	+ 57,40
Copper	84		
Titanium	12		
Polished	09	+ 432,60	+ 435,40

OPTIONAL WIRING ACCESS

MFC / MDF · Black Anti-fingerprint / Compact Laminate	PC	+ 30,80	+ 30,80
	QF	+ 78,40	+ 78,40
MFC / MDF · Black Anti-fingerprint	RF	+ 100,80	+ 100,80
Compact Laminate	RF	+ 124,60	+ 124,60
Glass	PC	+ 231,00	+ 231,00

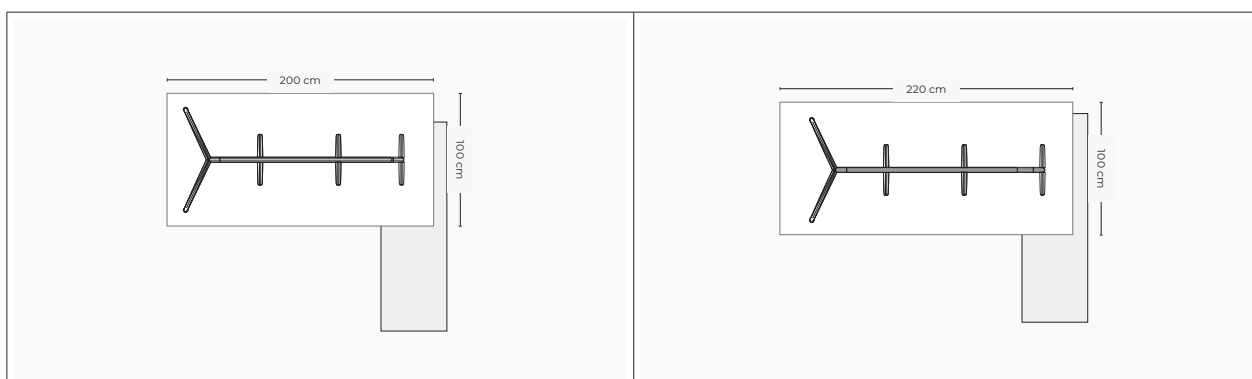


IMPORTANT NOTE:

When ordering the table with the optional **PC wiring access**, please refer to the accessories section to order the power and data connection integrated in the table top. The optional **PC wiring access** only includes the cut-out in the table top.

[CLICK TO COMPLEMENTS](#)

Arkitek · Operative tables
Tables with file support
Width 100 cm



Measures	200 x 100 cm · Reversible Cable management integrated in the file support	220 x 100 cm · Reversible Cable management integrated in the file support
Levelers	Height 74 cm	Height 74 cm
Reference	AK1E112010C	AK1E112210C

TYPE OF STRUCTURE			
Angled legs	C	2.045,40	2.163,00

SUPPORT			
Levelers	F		

DESK-TOP FINISHES					
Table	Body	Doors	Ref.		
MFC · White	MFC · White	Glass · White	M00V52		
		Glass · Black	M00V59		
MFC · Lime Oak	MFC · Lime Oak	Glass · White	M11V52		
		Glass · Black	M11V59		
MFC · Light Oak	MFC · Light Oak	Glass · White	M10V52		
		Glass · Black	M10V59		
MFC · Chestnut	MFC · Chestnut	Glass · White	M07V52		
		Glass · Black	M07V59		
MFC · Dark Oak	MFC · Dark Oak	Glass · Black	M14V59		
MDF · Black Anti.	MDF · Black Anti.	Glass · Black	M03V59	+ 347,20	+ 350,00
Compact Laminate · Traffic White	MFC · White	Glass · White	F20V52	+ 574,00	+ 590,80
		Glass · Black	F20V59		
Compact L. Samas Black	MDF · Black Anti.	Glass · Black	F28V59	+ 985,60	+ 1.114,40
Compact Laminate · Marmo Olimpo	MFC · White	Glass · White	F21V52	+ 1.351,00	+ 1.677,20
		Glass · Black	F21V59		
Compact L. Pulpis Light	MDF · Black Anti.	Glass · Black	F26V59	+ 1.478,40	+ 1.804,60
Glass · White	MFC · White	Glass · White	V52V52	+ 938,00	
Glass · Black	MDF · Black Anti.	Glass · Black	V59V59	+ 1.065,40	+ 1.093,40

STRUCTURE			
White	00		
Black	08		
Bronze	35		
Copper	84	+ 44,80	+ 47,60
Titanium	12		
Polished	09	+ 263,20	+ 266,00

OPTIONAL WIRING ACCESS			
MFC / MDF · Black Anti-fingerprint / Compact Laminate	QF	+ 78,40	+ 78,40
MFC / MDF · Black Anti-fingerprint	RF	+ 100,80	+ 100,80
Compact Laminate	RF	+ 124,60	+ 124,60

Meeting tables

Round

			
Measures	Ø 100 cm	Ø 130 cm	Ø 160 cm
Levelers	Height 74 cm	Height 74 cm	Height 74 cm
Reference	AK1G030100C	AK1G030130C	AK1G030160C

TYPE OF STRUCTURE				
Angled legs	C	637,00	681,80	1.421,00

SUPPORT				
Levelers	F			

DESK-TOP FINISHES				
MFC · White	M00			
MFC · Lime Oak	M11			
MFC · Light Oak	M10			
MFC · Chestnut	M07			
MFC · Dark Oak	M14			
MDF · Black Anti-fingerprint	M03	+ 140,00	+ 296,80	+ 666,40
Compact Laminate · Traffic White	F20	+ 330,40	+ 490,00	+ 901,60
Compact Laminate · Samas Black	F28	+ 471,80	+ 785,40	+ 1.260,00
Compact Laminate · Marmo Olimpo	F21	+ 718,20	+ 1.295,00	+ 1.880,20
Compact Laminate · Pulpis Light	F26			
* Glass · Transparent	V51	+ 565,60	+ 614,60	+ 1.199,80
* Glass · White	V52	+ 663,60	+ 900,20	+ 1.288,00
* Glass · Black	V59			

STRUCTURE				
White	00			
Black	08			
Bronze	35			
Copper	84	+ 40,60	+ 43,40	+ 70,00
Titanium	12			
Polished	09	+ 308,00	+ 313,60	+ 571,20

OPTIONAL WIRING ACCESS				
MFC / MDF · Black Anti-fingerprint / Compact Laminate	PC			+ 30,80
	QC			+ 78,40
MFC / MDF · Black Anti-fingerprint	RC			+ 100,80
Compact Laminate	RC			+ 124,60
Glass (*Two WIRING access)	PC			+ 462,00 *

*** IMPORTANT NOTE:**
The reference **AK1G030160C** with glass desk-top finishes the top surface are two pieces with support aluminium strip



IMPORTANT NOTE:
When ordering the table with the optional **PC wiring access**, please refer to the accessories section to order the power and data connection integrated in the table top. The optional **PC wiring access** only includes the cut-out in the table top.

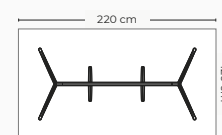
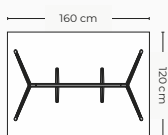
[CLICK TO COMPLEMENTS](#)

Prices shown are not the final selling price.
To obtain the list price, multiply the price by 2.65.
Prices effective as May 2025.

Arkitek · Operative tables

Meeting tables

Width 120 cm



Measures	160 x 120 cm	220 x 120 cm
Levelers	Height 74 cm	Height 74 cm
Reference	AK1G011612C	AK1G012212C

TYPE OF STRUCTURE

Angled legs	C	1.082,20	1.190,00
-------------	----------	----------	----------

SUPPORT

Levelers	F		
----------	----------	--	--

DESK-TOP FINISHES

MFC · White	M00		
MFC · Lime Oak	M11		
MFC · Light Oak	M10		
MFC · Chestnut	M07		
MFC · Dark Oak	M14		
MDF · Black Anti-fingerprint	M03	+ 285,60	+ 631,40
Compact Laminate · Traffic White	F20	+ 670,60	+ 806,40
Compact Laminate · Samas Black	F28	+ 1.029,00	+ 1.295,00
Compact Laminate · Marmo Olimpo	F21	+ 1.649,20	+ 2.143,40
Compact Laminate · Pulpis Light	F26		
Glass · Transparent	V51	+ 707,00	+ 1.499,40
Glass · White	V52	+ 884,80	
Glass · Black	V59	+ 884,80	+ 1.717,80

STRUCTURE

White	00		
Black	08		
Bronze	35		
Copper	84	+ 50,40	+ 57,40
Titanium	12		
Polished	09	+ 428,40	+ 435,40

OPTIONAL WIRING ACCESS

MFC / MDF · Black Anti-fingerprint / Compact Laminate	PC	+ 30,80	+ 30,80
Glass	PC	+ 231,00	+ 231,00

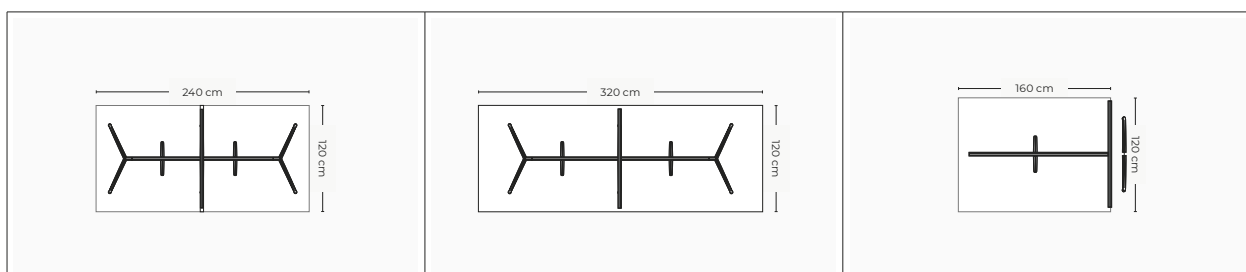


IMPORTANT NOTE:

When ordering the table with the optional **PC wiring access**, please refer to the accessories section to order the power and data connection integrated in the table top. The optional **PC wiring access** only includes the cut-out in the table top.

[CLICK TO COMPLEMENTS](#)

Meeting tables
Width 120 cm



Measures	240 x 120 cm	320 x 120 cm	160 x 120 cm - Progression
Levelers	Height 74 cm	Height 74 cm	Height 74 cm
Reference	AK1G012412C	AK1G013212C	AK1G021612C

TYPE OF STRUCTURE			
Angled legs	C	1.573,60	1.807,40

SUPPORT			
Niveladores	F		

DESK-TOP FINISHES			
MFC · White	M00		
MFC · Lime Oak	M11		
MFC · Light Oak	M10		
MFC · Chestnut	M07		
MFC · Dark Oak	M14		
MDF · Black Anti-fingerprint	M03	+ 483,00	+ 571,20
Compact Laminate · Traffic White	F20	+ 753,20	+ 1.341,20
Compact Laminate · Samaş Black	F28	+ 1.306,20	+ 2.058,00
Compact Laminate · Marmo Olimpo	F21	+ 2.261,00	+ 3.298,40
Compact Laminate · Pulpis Light	F26		+ 1.649,20
Glass · Transparent	V51	+ 1.121,40	+ 1.414,00
Glass · White	V52		+ 1.769,60
Glass · Black	V59	+ 1.395,80	+ 1.769,60

STRUCTURE			
White	00		
Black	08		
Bronze	35		
Copper	84	+ 79,80	+ 84,00
Titanium	12		
Polished	09	+ 645,40	+ 658,00

OPTIONAL WIRING ACCESS			
MFC / MDF · Black Anti-fingerprint / Compact Laminate	PC	+ 61,60	+ 61,60
Glass	PC	+ 462,00	+ 462,00



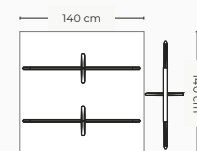
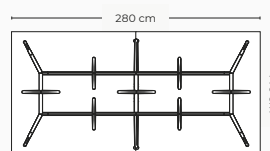
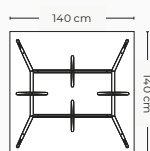
IMPORTANT NOTE:
When ordering the table with the optional **PC wiring access**, please refer to the accessories section to order the power and data connection integrated in the table top. The optional **PC wiring access** only includes the cut-out in the table top.

[CLICK TO COMPLEMENTS](#)

Arkitek · Operative tables

Meeting tables

Width 140 cm



Measures	140 x 140 cm	280 x 140 cm	140 x 140 cm - Progression
Levelers	Height 74 cm	Height 74 cm	Height 74 cm
Reference	AKIG011414C	AKIG012814C	AKIG021414C

TYPE OF STRUCTURE

Angled legs	C	1.482,60	2.599,80	1.215,20
-------------	----------	----------	----------	----------

SUPPORT

Levelers	F			
----------	----------	--	--	--

DESK-TOP FINISHES

MFC · White	M00			
MFC · Lime Oak	M11			
MFC · Light Oak	M10			
MFC · Chestnut	M07			
MFC · Dark Oak	M14			
MDF · Black Anti-fingerprint	M03	+ 572,60	+ 1.145,20	+ 572,60
Compact Laminate · Traffic White	F20	+ 641,20	+ 1.282,40	+ 641,20
Compact Laminate · Savaş Black	F28	+ 989,80	+ 1.979,60	+ 989,80
Compact Laminate · Marmo Olimpo	F21	+ 1.591,80	+ 3.183,60	+ 1.591,80
Compact Laminate · Pulpis Light	F26			
Glass · Transparent	V51	+ 1.195,60	+ 2.391,20	+ 1.195,60
Glass · White	V52	+ 1.314,60	+ 2.629,20	+ 1.314,60
Glass · Black	V59	+ 1.314,60	+ 2.629,20	+ 1.314,60

STRUCTURE

White	00			
Black	08			
Bronze	35			
Copper	84	+ 70,00	+ 131,60	+ 49,00
Titanium	12			
Polished	09	+ 571,20	+ 978,60	+ 375,20

OPTIONAL WIRING ACCESS

MFC / MDF · Black Anti-fingerprint / Compact Laminate	PC	+ 30,80	+ 61,60	+ 30,80
Glass	PC	+ 231,00	+ 462,00	+ 231,00

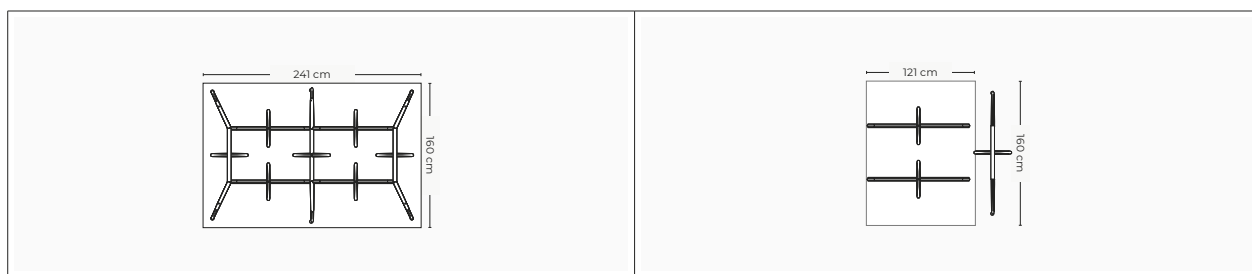


IMPORTANT NOTE:
When ordering the table with the optional **PC wiring access**, please refer to the accessories section to order the power and data connection integrated in the table top. The optional **PC wiring access** only includes the cut-out in the table top.

[CLICK TO COMPLEMENTS](#)

Meeting tables

Width 160 cm



Measures	241 x 160 cm	121 x 160 cm - Progresión
Levelers	Height 74 cm	Height 74 cm
Reference	AK1G012416C	AK1G021216C

TYPE OF STRUCTURE			
Angled legs	C	2.730,00	1.209,60

SUPPORT			
Levelers	F		

DESK-TOP FINISHES			
MFC · White	M00		
MFC · Lime Oak	M11		
MFC · Light Oak	M10		
MFC · Chestnut	M07		
MFC · Dark Oak	M14		
MDF · Black Anti-fingerprint	M03	+ 568,40	+ 285,60
Compact Laminate · Traffic White	F20	+ 1.341,20	+ 670,60
Compact Laminate · Samas Black	F28	+ 1.864,80	+ 932,40
Compact Laminate · Marmo Olimpo	F21	+ 2.774,80	+ 1.387,40
Compact Laminate · Pulpis Light	F26		
Glass · Transparent	V51	+ 1.414,00	+ 707,00
Glass · White	V52	+ 1.769,60	+ 884,80
Glass · Black	V59		

STRUCTURE			
White	00		
Black	08		
Bronze	35	+ 140,00	+ 47,60
Copper	84		
Titanium	12		
Polished	09	+ 949,20	+ 369,60

OPTIONAL WIRING ACCESS			
MFC / MDF · Black Anti-fingerprint / Compact Laminate	PC	+ 61,60	+ 30,80
	QC	+ 156,80	+ 78,40
MFC / MDF · Black Anti-fingerprint	RC	+ 201,60	+ 100,80
Compact Laminate	RC	+ 249,20	+ 124,60
Glass	PC	+ 462,00	+ 231,00

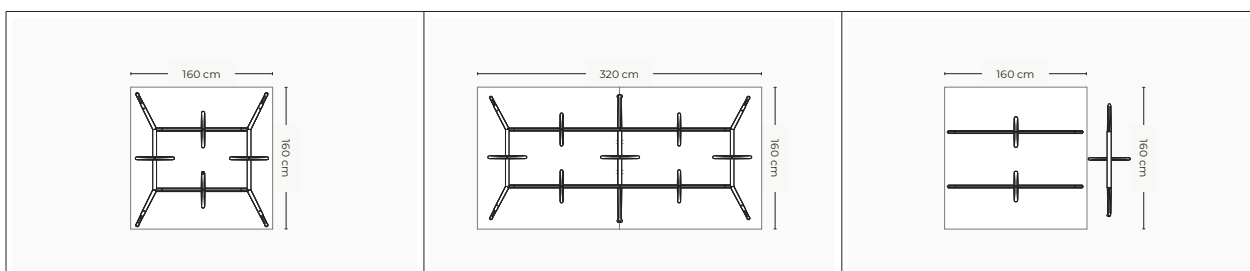


IMPORTANT NOTE:
When ordering the table with the optional **PC wiring access**, please refer to the accessories section to order the power and data connection integrated in the table top. The optional **PC wiring access** only includes the cut-out in the table top.

[CLICK TO COMPLEMENTS](#)

Prices shown are not the final selling price.
To obtain the list price, multiply the price by 2.65.
Prices effective as May 2025.

Arkitek · Operative tables
Double & meeting tables
Width 160 cm



Measures	160 x 160 cm	320 x 160 cm	160 x 160 cm - Progression
Levelers	Height 74 cm	Height 74 cm	Height 74 cm
Reference	AK1A041616C	AK1A053216C	AK1A061616C

TYPE OF STRUCTURE			
Angled legs	C	1.551,20	2.738,40

SUPPORT			
Levelers	F		

DESK-TOP FINISHES			
MFC · White	M00		
MFC · Lime Oak	M11		
MFC · Light Oak	M10		
MFC · Chestnut	M07		
MFC · Dark Oak	M14		
MDF · Black Anti-fingerprint	M03	+ 666,40	+ 1.331,40
Compact Laminate · Traffic White	F20	+ 884,80	+ 1.768,20
Compact Laminate · Samas Black	F28	+ 1.243,20	+ 2.485,00
Compact Laminate · Marmo Olimpo	F21	+ 1.863,40	+ 3.725,40
Compact Laminate · Pulpis Light	F26		+ 1.863,40
* Glass · Transparent	V51	+ 1.247,40	
* Glass · White	V52	+ 1.373,40	
* Glass · Black	V59		

STRUCTURE			
White	00		
Black	08		
Bronze	35		
Copper	84	+ 77,00	+ 135,80
Titanium	12		
Polished	09	+ 611,80	+ 999,60

OPTIONAL WIRING ACCESS			
MFC / MDF · Black Anti-fingerprint / Compact Laminate	PC	+ 30,80	+ 61,60
	QC	+ 78,40	+ 156,80
	QF	+ 156,80	+ 313,60
MFC / MDF · Black Anti-fingerprint	RC	+ 100,80	+ 201,60
	RF	+ 201,60	+ 403,20
Compact Laminate	RC	+ 124,60	+ 249,20
	RF	+ 249,20	+ 498,40
Glass (*Two WIRING access)	PC	+ 462,00 *	

*** IMPORTANT NOTE:**
The reference **AK1A041616C** with glass desk-top finishes the top surface are two pieces with support aluminium strip



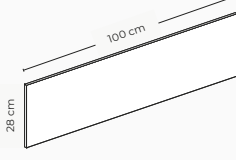
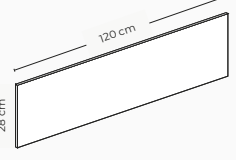
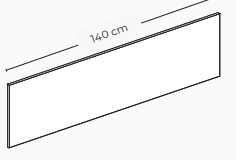
IMPORTANT NOTE:
When ordering the table with the optional **PC wiring access**, please refer to the accessories section to order the power and data connection integrated in the table top. The optional **PC wiring access** only includes the cut-out in the table top.

[CLICK TO COMPLEMENTS](#)

Prices shown are not the final selling price.
To obtain the list price, multiply the price by 2.65.
Prices effective as May 2025.

Available complements

Modesty panel Only for individual desks

			
Measures	100 x 28 cm	120 x 28 cm	140 x 28 cm
Compatibility	160 cm desks	180 cm desks	200 / 220 cm desks 200 / 220 cm tables with file support
Packs	Pack 1 unit	Pack 1 unit	Pack 1 unit
Reference	XAKFA11028	XAKFA11228	XAKFA11428

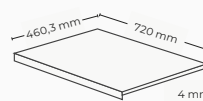
ANCHORING FINISH

White	00	99,40	106,40	112,00
Black	08			
Polished	09	+ 19,60	+ 19,60	+ 19,60

SURFACE FINISH

MFC · White	M00			
MFC · Lime Oak	M11			
MFC · Light Oak	M10			
MFC · Chestnut	M07			
MFC · Dark Oak	M14			
MFC · Black	M08			
Compact Laminate · Traffic White	F20	+ 72,80	+ 92,40	+ 107,80
Aluminium · White	A00	+ 117,60	+ 133,00	+ 158,20
Aluminium · Aluminium	A02			
Aluminium · Black	A08			
Glass · White	V52		+ 177,80	+ 193,20
Glass · Black	V59			

Pad manager Desk Protector





MEASURES	720 x 463 x 4 mm
REFERENCE	PAD5

INTEGRAL POLYURETHANE



Black	9	
Red	7	

77,00

Cable risers Flexible polystyrene		
MEASURES	800 x 40,5 mm / Ø 40,5 mm	800 x 40,5 mm / Ø 70 mm
COMPATIBILITY	For use with P, Q and R access containers.	
MINIMUM UNITS ORDER	3 units · Price for 1 unit	3 units · Price for 1 unit
REFERENCE	39425	39525


FLEXIBLE POLYSTYRENE FINISH

White	0	23,80	28,00
Black	8		

Cable risers Sheet metal		
MEASURES	520 x 80 x 50 mm	625 x 150 x 100 mm
COMPATIBILITY	For use on single, quadruple and double progression desks.	
REFERENCE	5070	5071

FINISHING SHEET METAL

White	0	117,60	140,00
Black	8		

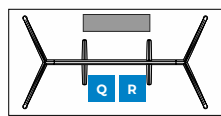
Cable risers Braided textile wrap		
PACKS	Pack 1 unit	Pack 4 units
MEASURES	750 mm / Ø 30 mm	
CHARACTERISTICS	Zippered for quick and easy installation. Offers additional protection against flame and abrasion.	
REFERENCE	39431	39434

FINISHING FABRIC

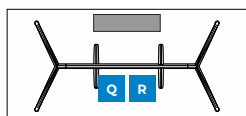
Black	8	39,20	137,20
-------	---	-------	--------

Compatibility of cable container for individual and meeting desks

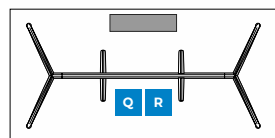
IMPORTANT NOTE:
Arkitek desking (operating desking) and tables (meeting tables) cannot be fitted with the cable container **with the PC wiring access.**



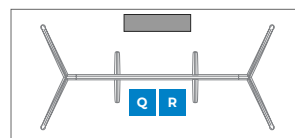
AK1A011680C



AK1A011888C



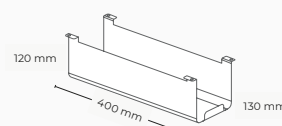
AK1F012010C



AK1F012210C

Accessories electrification systems

Individual desks



MEASURES	400 x 120 x 130 mm	
COMPATIBILITY	Container for electrification accessories with Q and R wiring access.	
PACKS	Pack 1 unit	Pack 2 units
REFERENCE	CQR11	CQR12

FINISHES

White	0	71,40	138,60
Black	8		

Explanation of use of the cable tray - desks de reunión

Arkitek includes a new cable management system for individual use only. The tray is hold in the central beam. Two sizes available:

-40 cm Channel for individual use 160, 180, 200 and 220cm desks.

-111,5 cm Channel for individual use 180, 200 and 220cm desks.



AK1A011680C



AK1A011888C



AK1F012010C



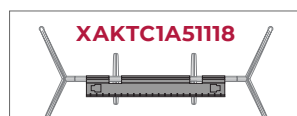
AK1F012210C



AK1A011888C



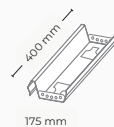
AK1F012010C



AK1F012210C

Simple Cable tray

Individual desks



Measures	400 x 175 mm	1115 x 181 mm
Compatibility	1600 / 1800 / 2000 / 220 cm desks	1800 / 2000 / 220 cm desks
Packs	Pack 1 unit	Pack 1 unit
Reference	XAKTC1A10417	XAKTC1A51118

TYPE OF ANCHOR

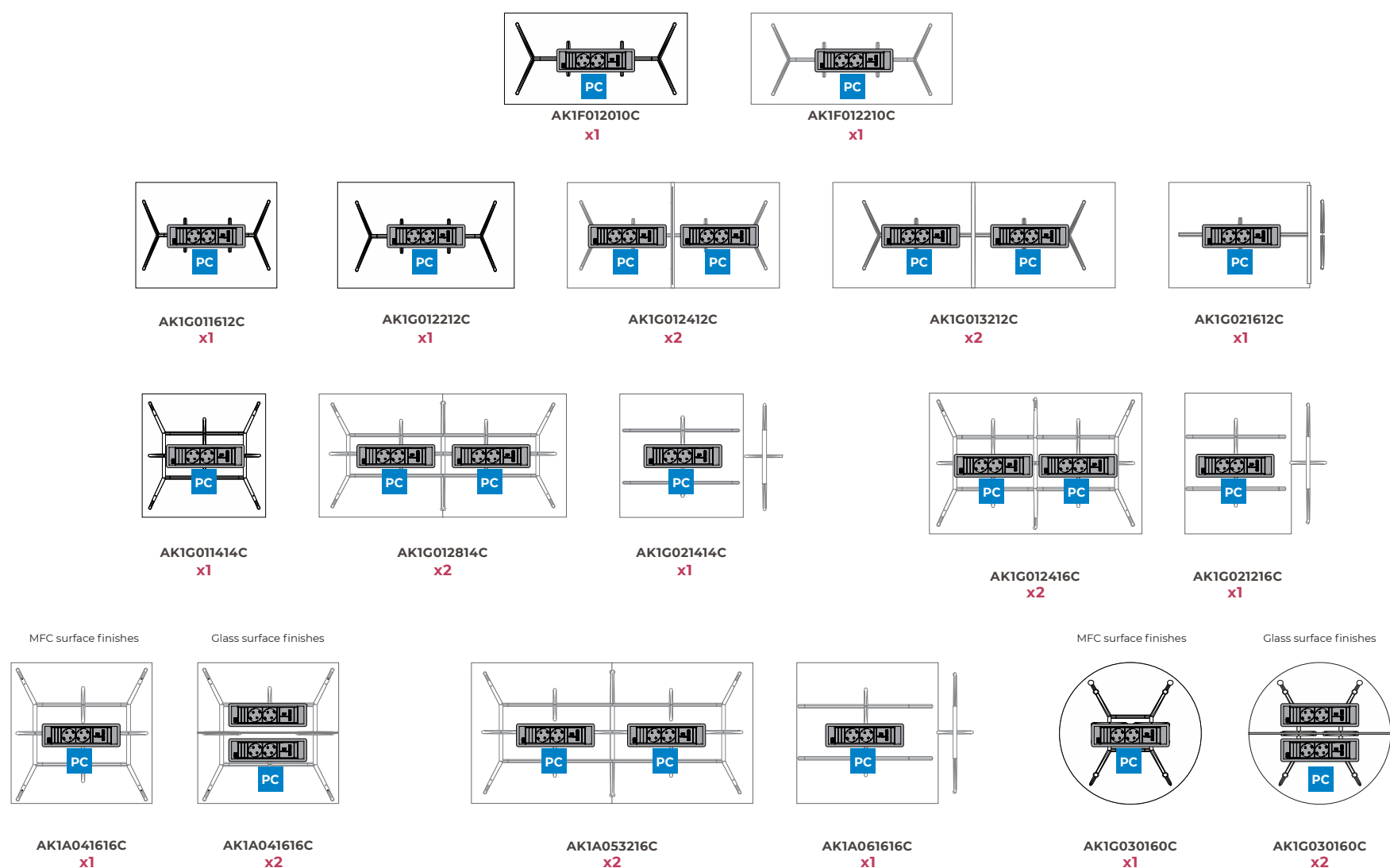
Fixed	A	49,00	93,80
-------	----------	-------	-------

SURFACE FINISH

Steel · White	C00		
Steel · Black	C08		

Power and data connection compatibility for meeting desks

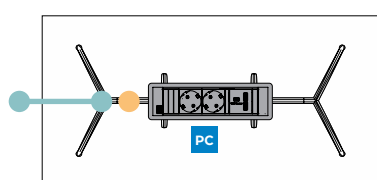
Locate the requested table model to order the necessary power connection units for all meeting desks.



Example of power connection

Please refer to the following examples to order all the components required for the desired configuration. The **GX21** mains power cable must always be ordered. The power distributor **GX22** is included in the power connection with USB charging. In case of ordering a table with progressive desk and **power connection with HDMI**, the **GX22 connection spread kit** must be ordered for the progressive desk.

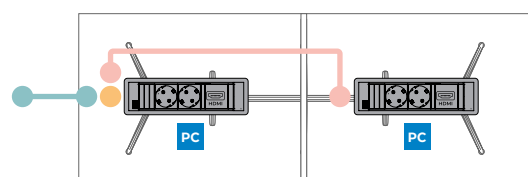
EXAMPLE 01



AK1G012212C

COMPONENTS	DESCRIPTION	UNITS
AK1G012212CCCFM0000PC	Meeting table 220 x 120 cm with PC cable access	x1
XELBCP122081EU99	Power connection with 2 sockets + 2 USB charging sockets and without cover	x1
· GX21	2 metres extension cable, end power entry. EU · 220v	x1
· GX22	Connection spread kit	INCLUDED

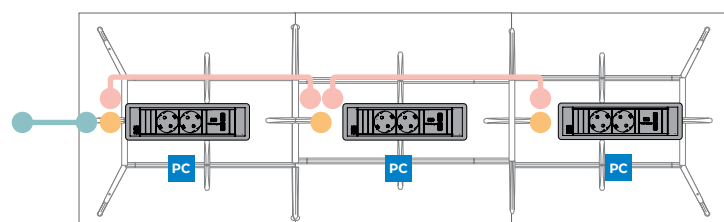
EXAMPLE 02



AK1G013212C

COMPONENTS	DESCRIPTION	UNITS
AK1G013212CCCFM0000PC	Meeting table 320 x 160 cm with PC cable access	x1
XELBCP222081EU99	Power connection with 2 sockets + 1 HDMI and without cover	x2
· GX21	2 metres extension cable, end power entry. EU · 220v	x1
· GX22	Connection spread kit	x1
· GX20	Extension cable (1'5 m.)	x1

EXAMPLE 03



AK1G013216C

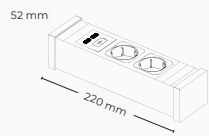
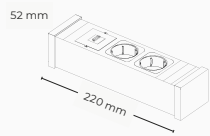
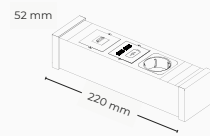
AK1G021616C

AK1G013216C

COMPONENTS	DESCRIPTION	UNITS
AK1G013216CCCFM0000PC	Meeting table 320 x 160 cm with PC cable access	x1
AK1G021616CCCFM0000PC	Extension table 160 x 160 cm with PC cable access	x1
XELBCP122081EU99	Power connection with 2 sockets + 2 USB charging sockets and without cover	x3
· GX21	2 metres extension cable, end power entry. EU · 220v	x1
· GX22	Connection spread kit	INCLUDED
· GX20	Extension cable (1'5 m.)	x2

Prices shown are not the final selling price.
To obtain the list price, multiply the price by 2.65.
Prices effective as May 2025.

IMPORTANT NOTE:
When ordering a power and data connection for a transparent glass top surface, it is compulsory to order the additional cover plate to conceal the cables.






Power and data connection Meeting desks				
	COMPONENTS 2 plugs + 2 USB charging sockets type A and C GX22 INCLUDED (Connection spread kit)	2 plugs + 1 HDMI	1 plug + 1 HDMI + 2 USB charging sockets type A and C GX22 INCLUDED (Connection spread kit)	
	COMPATIBILITY	Integrated power and data connection for meeting desks with PC wiring access		
	PACKS	Pack 1 unit	Pack 1 unit	Pack 1 unit
	REFERENCE	XELBCP122	XELBCP222	XELBCP322

FRAME FINISH / INITIAL PRICE				
Black	08	327,60	250,60	396,20

CONNECTIVITY				
EU · 220V	1EU			
US · 120V	1US	+ 18,20	+ 18,20	+ 18,20
UK · 220V	1UK	+ 35,00	+ 35,00	+ 35,00

OPTIONAL TOP COVER				
Without cover	99			
White	00	+ 252,00	+ 252,00	+ 252,00
Black	08	+ 252,00	+ 252,00	+ 252,00

MANDATORY COMPLEMENT FOR TRANSPARENT GLASS TOP SURFACE				
Trim container	XT	+ 53,20	+ 53,20	+ 53,20

Electrical accessories Meeting desks						
	COMPONENTS	Extension cable (1'5 m.)	End power entry 2 mts. EU · 220V	End power entry 2 mts. UK · 220V	End power entry 2 mts. US · 120V	Connection spread kit.
	DESCRIPTION	Ø 10 mm. (3 x 2'5). Rubber hose Male and female connector to connect additional power module.	Ø 8 mm. (3 x 2). Rubber hose Plug and ground Ø 4'8 / 16A Female terminal plugged (with protection).			1 input / 3 outputs
	MINIMUM UNITS ORDER	4 units · Price for 1 unit	4 units · Price for 1 unit	4 units · Price for 1 unit	4 units · Price for 1 unit	5 units · Price for 1 unit
	REFERENCE	GX20	GX21	GX21L	GX21D	GX22
PRICE	40,60	43,40	43,40	43,40	28,00	

Explanation of use of the cable tray - desks de reunión

Use of cable tray on **Meeting desks of 120 cm:**
To use electrification cable tray on desks of 120 cm width, request the desired/corresponding model, which is listed on the pricelist:

- 40 cm Channel for individual use 160, 220, 320 and 160(progressive) cm desks.
- 111,5 cm Channel for individual use 220cm desks.

XAKTC1A10417



AK1G011612C

XAKTC1A10417



AK1G012212C

XAKTC1A10417 **XAKTC1A10417**



AK1G013212C

XAKTC1A10417



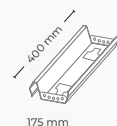
AK1G021612C

XAKTC1A51118



AK1G012212C

Simple Cable tray Individual desks



Measures	400 x 175 mm	1115 x 181 mm
Compatibility	1600 / 2200 / 3200 / 160 cm desks	220 cm desks
Packs	Pack 1 unit	Pack 1 unit
Reference	XAKTC1A10417	XAKTC1A51118

TYPE OF ANCHOR

Fixed	A	49,00	93,80
-------	----------	-------	-------

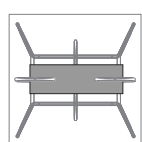
SURFACE FINISH

Steel · White	C00		
Steel · Black	C08		

Use of cable tray on **Meeting desks of 140 cm:**
To use electrification cable tray on desks of 140 cm width, request the desired/corresponding model, which is listed on the pricelist:

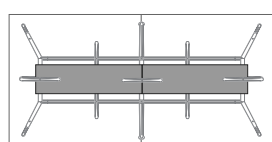
- 44cm width Recessed Cable tray: Use on AK1G011414C meeting desk - Length 116 cm.
- 44cm width Recessed Cable tray: Use on AK1G012814C meeting desk - Length 122 cm.
- 44cm width Recessed Cable tray: Use on AK1G021414C meeting desk - Length 139 cm.

XAKTC1B51142



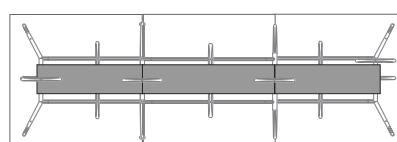
AK1G011414C

XAKTC1B51242 **XAKTC1B51242**



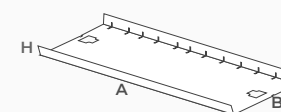
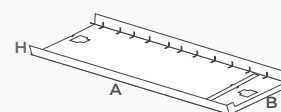
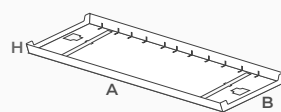
AK1G012814C

XAKTC1B51242 **XAKTC1C51442** **XAKTC1B51242**



AK1G012814C + AK1G021414C

Cable tray Meeting tables · 140 cm wide



Measures	1160 x 440 mm	1228 x 440 mm	1399 x 440 mm
Compatibility	140 x 140 cm desks	2800 x 140 cm desks	140 x 140 cm progression desks
Packs	Pack 1 unit	Pack 2 unit	Pack 1 unit
Reference	XAKTC1B51142	XAKTC1B51242	XAKTC1C51442

TYPE OF ANCHOR

Fixed	A	208,60	347,20	172,20
-------	----------	--------	--------	--------

SURFACE FINISH

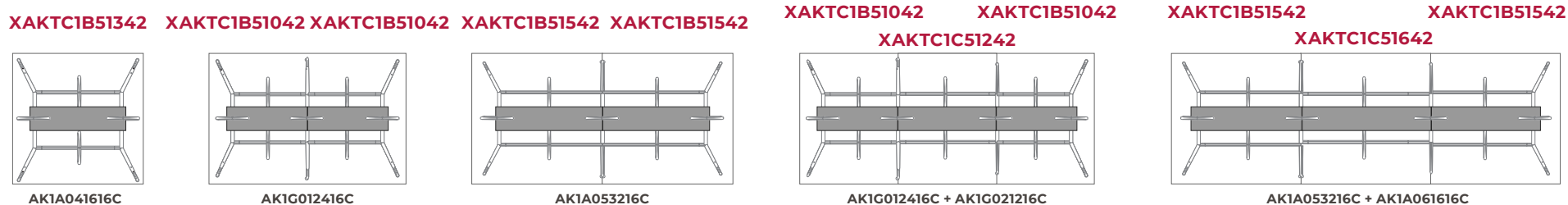
Steel · White	C00			
Steel · Black	C08			

EXPLANATION OF USE OF THE CABLE TRAY - DOUBLE OPERATIVE DESKS, EXTENDABLE DOUBLE DESKS AND MEETING DESKS

Use of cable tray on **double operative desks, extendable double desks and meeting desks of 160 cm:**

To use electrification cable tray on desks of 160 cm width, request the desired/corresponding model, which is listed on the pricelist:

- 44cm width Recessed Cable tray: Use on AK1G011414C - 136 cm length.
- 44cm width Recessed Cable tray: Use on AK1G012416C - 102 cm length.
- 44cm width Recessed Cable tray: Use on AK1A053216C - 144 cm length.
- 44cm width Recessed Cable tray: Use on AK1G021216C - 119 cm length.
- 44cm width Recessed Cable tray: Use on AK1A061616C - 159 cm length.



Telecanal double

Double & meeting tables · Width 160 cm

Measures	1360 x 440 mm	1028 x 440 mm	1428 x 440 mm	1199 x 440 mm	1599 x 440 mm
Compatibility	1600 x 160 cm desks	2400 x 160 cm desks	3200 x 160 cm desks	120 x 160 cm desks	1600 x 160 cm desks
Packs	Pack 1 unit	Pack 2 units	Pack 2 units	Pack 1 unit	Pack 1 unit
Reference	XAKTC1B51342	XAKTC1B51042	XAKTC1B51542	XAKTC1C51242	XAKTC1C51642

TYPE OF ANCHOR

Fixed	A	218,40	334,60	361,20	163,80	180,60
-------	----------	--------	--------	--------	--------	--------

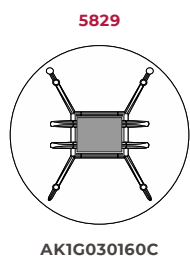
SURFACE FINISH

Steel · White	C00					
Steel · Black	C08					

Use of cable tray on **meeting tables round diameter 160 cm:**

To use electrification cable tray on desks of 160 cm diameter, request the desired/corresponding model, which is listed on the pricelist:

- 42cm width Recessed Cable tray: Use on AK1G030160C - 160 cm diameter.



Cable tray

160 cm diameter desks

MEASURES	500 x 420 x 30,8 mm
COMPATIBILITY	For use on AK1G030160C
REFERENCE	5829

STRUCTURE

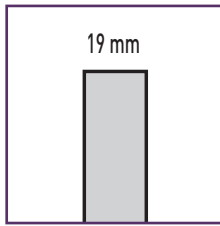
White	0	74,20
Black	8	



■ **Desks mounted screens**

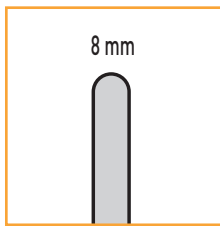
Desk-Mounted screens, different sizes available, fixing kits and finishes. Easy to be adapted to any surface. They provide visual contact but at the same time privacy. Twin desks with electrification system have their own desk-mounted screens (**D50 Serie for Vital or Arkitek**)

■ **DESK MOUNTED SCREENS OFFER**



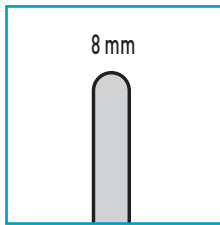
MFC SCREEN - e=19mm

19 mm thick Chipboard



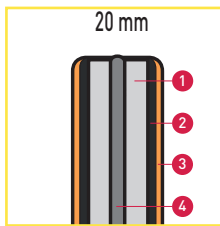
GLASS SCREEN - e=8mm

Laminatd Security Glass (4+4 mm) / Tempered glass (8 mm)



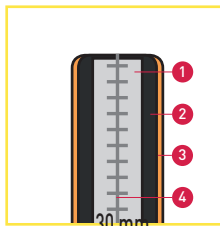
METHACRYLATE SCREEN - e=8mm

8 mm thick White Methacrylathe



UPHOLSTERED SCREEN WITH FLEXIBLE PROFILE - e=30mm

- ① 19 mm thick Chipboard
- ② Foam thickness e= 5 mm and 60 Kg/m³ density (etotal= 30 mm)
- ③ Different fabrics available glued using water glue.
- Optional accoustic or fire resistant fabrics for projects.
- ④ 8mm thick flexible Profile



UPHOLSTERED SCREEN. SEWAN AND SEATHED - e=30mm

- ① 19 mm thick Chipboard
- ② Foam thickness e= 5 mm and 60 Kg/m³ density (etotal= 30 mm)
- ③ Different fabrics available glued using water glue.
- Optional accoustic or fire resistant fabrics for projects.
- ④ Sewn and sheathed.

Prices shown are not the final selling price.
To obtain the list price, multiply the price by 2.65.
Prices effective as May 2025.

EXAMPLE OF AN ORDER

Model	Bracket finish	Divider Finish	Final Reference
DLN432 Screen mobile Pack 2 units	N Black bracket	T82 Group T Upholstered	DLN432NT82

TABLE TOP DIVIDERS - SUPPORT ON DISCS

Support on discs with anti slip pad.

Upholstered divider e=30 mm

Upholstered divider e=30 mm

Model Dimensions (A x B)	ZW43 110 38 <input type="text"/>	ZW44 130 38 <input type="text"/>	ZW45 150 38 <input type="text"/>
	TABLE TOP DIVIDER FOR 120, 140 and 160 cm DESK	TABLE TOP DIVIDER FOR 140 and 160 cm DESK	TABLE TOP DIVIDER FOR 160 cm DESK

Coding required to configure reference.
They do not mean an increase in cost

Units / Pack		Pack 1 Unit	Pack 2 Units	Pack 1 Unit	Pack 2 Units	Pack 1 Unit	Pack 2 Units
Base Reference		ZW431	ZW432	ZW441	ZW442	ZW451	ZW452
Bracket finish	WHITE	0					
	BLACK	8					

FLEXIBLE PROFILE UPHOLSTERED DIVIDER e= 30 mm - h= 38 cm

Upholstered e=30 Flexible profile	GROUP 0	Group T	3T--	189,00	358,40	194,60	373,80	207,20	403,20
				GROUP 1	Group AE	3AE--	215,60	414,40	228,20
GROUP 2	Group AO	3AO--	226,80				443,80	242,20	469,00
			GROUP 2	Group D	3D--				
GROUP 2	Group M	3M--							

Model Dimensions (A x B)	DLN43 110 38 <input type="text"/>	DLN44 130 38 <input type="text"/>	DLN45 150 38 <input type="text"/>
	TABLE TOP DIVIDER FOR 140 and 160 cm DESK	TABLE TOP DIVIDER FOR 140 and 160 cm DESK	TABLE TOP DIVIDER FOR 160 cm DESK

Units / Pack		Pack 1 Unit	Pack 2 Units	Pack 1 Unit	Pack 2 Units	Pack 1 Unit	Pack 2 Units
Base Reference		DLN431	DLN432	DLN441	DLN442	DLN451	DLN452
Bracket finish	WHITE	B					
	BLACK	N					

SEWN AND SHEATHED UPHOLSTERED DIVIDER e= 30 mm - h= 38 cm

Upholstered e=30 Sewn and sheathed	GROUP 0	Group T	T--	222,60	431,20	228,20	446,60	245,00	476,00
				GROUP 1	Group AE	AE--	249,20	487,20	264,60
GROUP 2	Group AO	AO--	263,20				515,20	278,60	543,20
			GROUP 2	Group D	D--				
GROUP 3	Group M	M--							
			GROUP 3	Group A	A--	310,80	609,00	333,20	651,00

Prices shown are not the final selling price.
To obtain the list price, multiply the price by 2.65.
Prices effective as May 2025.

EXAMPLE OF AN ORDER

Model	Bracket finish	Divider Finish	Final Reference
ZK232 Screen for frontal use Pack 2 units	0 White bracket	3T82 Group T Upholstered	ZK23203T82


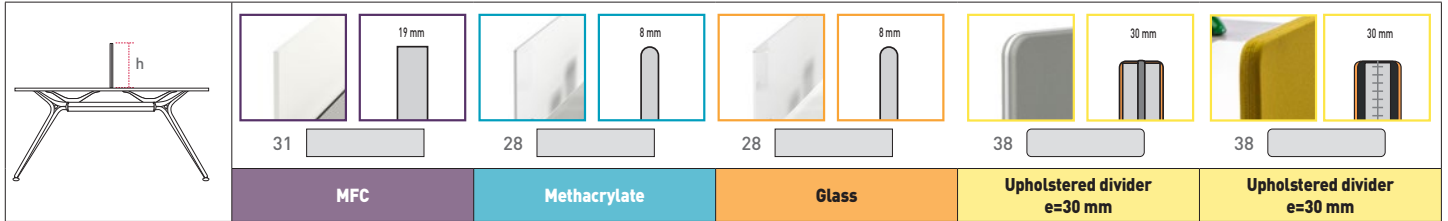
 Coding required to configure reference.
They do not mean an increase in cost

TABLE TOP DIVIDERS FOR - FRONTAL USE ON DOUBLE DESKS



Model Dimensions (A x B)		ZK23 110	ZK24 130	ZK25 150						
		FOR 140, 160 and 180 cm DESK		FOR 140, 160 and 180 cm DESK		FOR 160 and 180 cm DESK				
Units / Pack		Pack 1 Unit	Pack 2 Units.	Pack 1 Unit	Pack 2 Units.	Pack 1 Unit	Pack 2 Units.			
Base Reference		ZK231	ZK232	ZK241	ZK242	ZK251	ZK252			
Bracket finish	WHITE	0								
MFC DIVIDER e = 19 mm - h= 31 cm										
MFC		White	00	82,60	154,00	85,40	159,60	91,00	169,40	
		Black	08	82,60	154,00	85,40	159,60	91,00	169,40	
METHACRYLATE DIVIDER e = 8 mm - h= 28 cm										
Methacrylate		White	90	154,00	291,20	165,20	316,40	176,40	340,20	
GLASS DIVIDER e = 8 mm - h= 28 cm										
Glass		White	52	273,00	529,20	301,00	586,60	330,40	644,00	
FLEXIBLE PROFILE UPHOLSTERED DIVIDER e= 30 mm - h= 38 cm										
Upholstered e= 30 Flexible profile	GROUP 0		Group T	3T--	163,80	313,60	170,80	326,20	186,20	355,60
			Group AE	3AE--	191,80	369,60	204,40	393,40	247,80	481,60
		Group AO	3AO--							
	GROUP 2		Group D	3D--	204,40	396,20	218,40	425,60	275,80	534,80
			Group M	3M--						
SEWN AND SHEATHED UPHOLSTERED DIVIDER e= 30 mm - h= 38 cm										
Upholstered e= 30 Sewn and sheathed	GROUP 0		Group T	T--	198,80	386,40	205,80	399,00	221,20	428,40
			Group AE	AE--	226,80	442,40	242,20	471,80	281,40	551,60
		Group AO	AO--							
	GROUP 2		Group D	D--	240,80	464,80	254,80	497,00	310,80	609,00
			Group M	M--						
	GROUP 3		Group A	A--	287,00	561,40	309,40	604,80	372,40	732,20