

## Grada Indoor

Manufacturer: Expormim, Spain

### Grada Indoor Lievore Altherr Molina, 2017/2021

Tabletop made of solid wood from European oaks with 21 mm/0.83" of section. Structure made of stainless steel tube, finished with polyester powder. The collection is also available in a lacquered version (MDF) and in European oak plywood. Delivered unassembled.

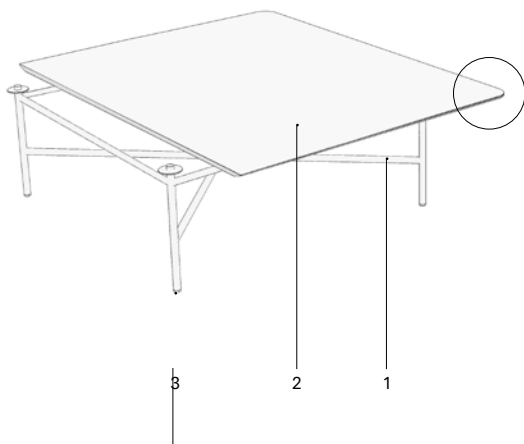

- 1 Structure made of stainless steel tube AISI 304, finished with polyester powder.
- 2 Tabletop options:
  - Veneered top 21 mm/0.83" thick.
  - Lacquered top 21 mm/0.83" thick.
- 3 Injected PA spacers.



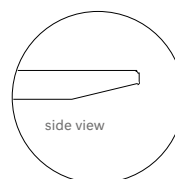





Tabletop options:



- veneered top 21 mm/0.83" thick.
- lacquered top 21 mm/0.83" thick.



## Grada Indoor

Manufacturer: Expormim, Spain

Ref.	Article	Options	Total (CAD\$)	
			lacquered top	veneered top
<b>T912</b>	<b>Square coffee table</b>			
	 <p>100x100x30 39.25" x 39.25" x 11.75"</p>	<p><b>frame</b></p> <ul style="list-style-type: none"> <li>102 FT light grey, 108 FT oxide, 110 FT bronze, 111 FT graphite, 124 FT linen</li> </ul> <p><b>lacquered top</b></p> <ul style="list-style-type: none"> <li>LT09 champagne, LT10 bronze, LT11 graphite, LT24 linen, LT26 sable brown, L5 taupe</li> </ul> <p><b>veneered top</b></p> <ul style="list-style-type: none"> <li>W01 natural oak, W02 white stained, W03 light oak, W05 dark stained</li> </ul> <p><b>solid wood top</b></p> <ul style="list-style-type: none"> <li>W01 natural oak, W02 white stained, W03 light oak, W05 dark stained</li> </ul> <p> 19 kg —  26 kg / 0,30 m<sup>3</sup></p>	\$2,526	\$3,090
<b>T913</b>	<b>Square coffee table</b>			
	 <p>100x100x36 39.25" x 39.25" x 14.25"</p>	<p><b>frame</b></p> <ul style="list-style-type: none"> <li>102 FT light grey, 108 FT oxide, 110 FT bronze, 111 FT graphite, 124 FT linen</li> </ul> <p><b>lacquered top</b></p> <ul style="list-style-type: none"> <li>LT09 champagne, LT10 bronze, LT11 graphite, LT24 linen, LT26 sable brown, L5 taupe</li> </ul> <p><b>veneered top</b></p> <ul style="list-style-type: none"> <li>W01 natural oak, W02 white stained, W03 light oak, W05 dark stained</li> </ul> <p><b>solid wood top</b></p> <ul style="list-style-type: none"> <li>W01 natural oak, W02 white stained, W03 light oak, W05 dark stained</li> </ul> <p> 19 kg —  26 kg / 0,31 m<sup>3</sup></p>	\$2,607	\$3,171
<b>T914</b>	<b>Rectangular coffee table</b>			
	 <p>130x80x30 51.25" x 31.5" x 11.75"</p>	<p><b>frame</b></p> <ul style="list-style-type: none"> <li>102 FT light grey, 108 FT oxide, 110 FT bronze, 111 FT graphite, 124 FT linen</li> </ul> <p><b>lacquered top</b></p> <ul style="list-style-type: none"> <li>LT09 champagne, LT10 bronze, LT11 graphite, LT24 linen, LT26 sable brown, L5 taupe</li> </ul> <p><b>veneered top</b></p> <ul style="list-style-type: none"> <li>W01 natural oak, W02 white stained, W03 light oak, W05 dark stained</li> </ul> <p><b>solid wood top</b></p> <ul style="list-style-type: none"> <li>W01 natural oak, W02 white stained, W03 light oak, W05 dark stained</li> </ul> <p> 20 kg —  26 kg / 0,31 m<sup>3</sup></p>	\$2,721	\$3,249









## Grada Indoor

Manufacturer: Expormim, Spain

Ref.	Article	Options	Total (CAD\$)	
			lacquered top	veneered top
<b>T915</b>	<b>Rectangular coffee table</b>			
	 <p>130x80x36 51.25" x 31.5" x 14.25"</p>	<p><b>frame</b></p> <ul style="list-style-type: none"> <li>102 FT light grey, 108 FT oxide, 110 FT bronze, 111 FT graphite, 124 FT linen</li> </ul> <p><b>lacquered top</b></p> <ul style="list-style-type: none"> <li>LT09 champagne, LT10 bronze, LT11 graphite, LT24 linen, LT26 sable brown, L5 taupe</li> </ul> <p><b>veneered top</b></p> <ul style="list-style-type: none"> <li>W01 natural oak, W02 white stained, W03 light oak, W05 dark stained</li> </ul> <p><b>solid wood top</b></p> <ul style="list-style-type: none"> <li>W01 natural oak, W02 white stained, W03 light oak, W05 dark stained</li> </ul> <p>📦 20 kg — 📦 26 kg / 0,31 m<sup>3</sup></p>	\$2,802	\$3,330
<b>T916</b>	<b>Round coffee table</b>			
	 <p>Ø 100x30 Ø 39.25" x 11.75"</p>	<p><b>frame</b></p> <ul style="list-style-type: none"> <li>102 FT light grey, 108 FT oxide, 110 FT bronze, 111 FT graphite, 124 FT linen</li> </ul> <p><b>lacquered top</b></p> <ul style="list-style-type: none"> <li>LT09 champagne, LT10 bronze, LT11 graphite, LT24 linen, LT26 sable brown, L5 taupe</li> </ul> <p><b>veneered top</b></p> <ul style="list-style-type: none"> <li>W01 natural oak, W02 white stained, W03 light oak, W05 dark stained</li> </ul> <p><b>solid wood top</b></p> <ul style="list-style-type: none"> <li>W01 natural oak, W02 white stained, W03 light oak, W05 dark stained</li> </ul> <p>📦 15 kg — 📦 22 kg / 0,22 m<sup>3</sup></p>	\$2,523	\$2,988
<b>T917</b>	<b>Round coffee table</b>			
	 <p>Ø 100x36 Ø 39.25" x 14.25"</p>	<p><b>frame</b></p> <ul style="list-style-type: none"> <li>102 FT light grey, 108 FT oxide, 110 FT bronze, 111 FT graphite, 124 FT linen</li> </ul> <p><b>lacquered top</b></p> <ul style="list-style-type: none"> <li>LT09 champagne, LT10 bronze, LT11 graphite, LT24 linen, LT26 sable brown, L5 taupe</li> </ul> <p><b>veneered top</b></p> <ul style="list-style-type: none"> <li>W01 natural oak, W02 white stained, W03 light oak, W05 dark stained</li> </ul> <p><b>solid wood top</b></p> <ul style="list-style-type: none"> <li>W01 natural oak, W02 white stained, W03 light oak, W05 dark stained</li> </ul> <p>📦 15 kg — 📦 22 kg / 0,24 m<sup>3</sup></p>	\$2,604	\$3,069

## Grada Indoor

Manufacturer: Expormim, Spain

Ref.	Article	Options	Total (CAD\$)	
			lacquered top	veneered top
<b>T907</b>	<b>Round coffee table</b>			
	 <p>Ø 70x30 Ø 27.5" x 11.75"</p>	<p><b>frame</b></p> <ul style="list-style-type: none"> <li>102 FT light grey, 108 FT oxide, 110 FT bronze, 111 FT graphite, 124 FT linen</li> </ul> <p><b>lacquered top</b></p> <ul style="list-style-type: none"> <li>LT09 champagne, LT10 bronze, LT11 graphite, LT24 linen, LT26 sable brown, L5 taupe</li> </ul> <p><b>veneered top</b></p> <ul style="list-style-type: none"> <li>W01 natural oak, W02 white stained, W03 light oak, W05 dark stained</li> </ul> <p><b>solid wood top</b></p> <ul style="list-style-type: none"> <li>W01 natural oak, W02 white stained, W03 light oak, W05 dark stained</li> </ul> <p> 7 kg —  11 kg / 0,13 m<sup>3</sup></p>	\$1,647	\$1,857
<b>T910</b>	<b>Side table</b>			
	 <p>Ø 50x45 Ø 19.75" x 17.75"</p>	<p><b>frame</b></p> <ul style="list-style-type: none"> <li>102 FT light grey, 108 FT oxide, 110 FT bronze, 111 FT graphite, 124 FT linen</li> </ul> <p><b>lacquered top</b></p> <ul style="list-style-type: none"> <li>LT09 champagne, LT10 bronze, LT11 graphite, LT24 linen, LT26 sable brown, L5 taupe</li> </ul> <p><b>veneered top</b></p> <ul style="list-style-type: none"> <li>W01 natural oak, W02 white stained, W03 light oak, W05 dark stained</li> </ul> <p><b>solid wood top</b></p> <ul style="list-style-type: none"> <li>W01 natural oak, W02 white stained, W03 light oak, W05 dark stained</li> </ul> <p> 4 kg —  6 kg / 0,15 m<sup>3</sup></p>	\$1,431	\$1,620
<b>T919</b>	<b>Round coffee table</b>			
	 <p>Ø 70x36 Ø 27.5" x 14.25"</p>	<p><b>frame</b></p> <ul style="list-style-type: none"> <li>102 FT light grey, 108 FT oxide, 110 FT bronze, 111 FT graphite, 124 FT linen</li> </ul> <p><b>lacquered top</b></p> <ul style="list-style-type: none"> <li>LT09 champagne, LT10 bronze, LT11 graphite, LT24 linen, LT26 sable brown, L5 taupe</li> </ul> <p><b>veneered top</b></p> <ul style="list-style-type: none"> <li>W01 natural oak, W02 white stained, W03 light oak, W05 dark stained</li> </ul> <p><b>solid wood top</b></p> <ul style="list-style-type: none"> <li>W01 natural oak, W02 white stained, W03 light oak, W05 dark stained</li> </ul> <p> 7 kg —  11 kg / 0,13 m<sup>3</sup></p>	\$1,728	\$1,938

## Grada Indoor

Manufacturer: Expormim, Spain

Ref.	Article	Options	Total (CAD\$)	
			lacquered top	veneered top

### T941 Round coffee table



Ø 80x30  
Ø 31.5" x 11.75"

#### frame

- 102 FT light grey, 108 FT oxide, 110 FT bronze, 111 FT graphite, 124 FT linen

\$1,740    \$2,127

#### lacquered top

- LT09 champagne, LT10 bronze, LT11 graphite, LT24 linen, LT26 sable brown, L5 taupe

#### veneered top

- W01 natural oak, W02 white stained, W03 light oak, W05 dark stained

#### solid wood top

- W01 natural oak, W02 white stained, W03 light oak, W05 dark stained

9 kg — 13 kg / 0,14 m³

### T942 Round coffee table



Ø 80x36  
Ø 31.5" x 14.25"

#### frame

- 102 FT light grey, 108 FT oxide, 110 FT bronze, 111 FT graphite, 124 FT linen

\$1,821    \$2,208

#### lacquered top

- LT09 champagne, LT10 bronze, LT11 graphite, LT24 linen, LT26 sable brown, L5 taupe

#### veneered top

- W01 natural oak, W02 white stained, W03 light oak, W05 dark stained

#### solid wood top

- W01 natural oak, W02 white stained, W03 light oak, W05 dark stained

9 kg — 13 kg / 0,14 m³

## Grada Outdoor

Manufacturer: Expormim, Spain

Grada for Indoor and outdoor.  
Lievore Altherr Molina, 2016/2020

---

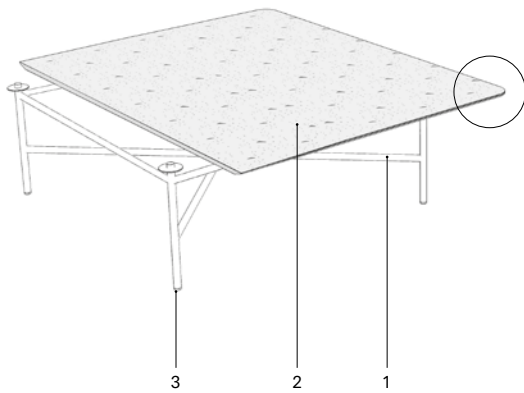

- 1 Structure made of stainless steel tube AISI 304, finished with polyester powder.
- 2 Tabletop options:
  - HPL Trespa® 13 mm/0.51" thick.
  - FENIX NTM® 12 mm/0.47" thick.
  - Dekton® 12 mm/0.47".
- 3 Injected PA spacers.

Tabletop options:

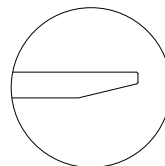

- HPL Trespa® 13 mm/0.51" thick.
- FENIX NTM® 12 mm/0.47" thick.

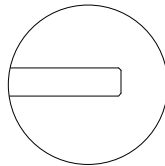

- Dekton® 12 mm/0.47" thick.

## Grada outdoor

Manufacturer: Expormim, Spain

REF	ARTICLE	OPTIONS	TOTAL (CAD\$)
-----	---------	---------	---------------

### C912 Square coffee table

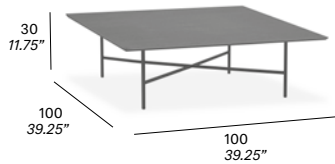

#### frame \*

- 102 FT light grey, 108 FT oxide, 110 FT bronze, 111 FT graphite, 113 FT sage, 120 FT off white, 124 FT linen

#### HPL premium top 13 mm/0.51" 3,735

- 320 silver quartzite, 321 italian slate, 323 natural chalkstone, 327 titanium bronze

#### FENIX NTM® top 12 mm/0.47" 4,317

- 029 bianco male, 720 nero ingo

#### Dekton® top 8 mm/0.31" 5,415

- K1 albarium, K2 argentium, K3 umber, K4 micron
- D2 kelya, D3 danae

#### protective cover +476

21 kg — 28 kg / 0,30 m³ — (HPL top, FENIX top option)

31 kg — 38 kg / 0,30 m³ — (dekton top option)

### C913 Square coffee table

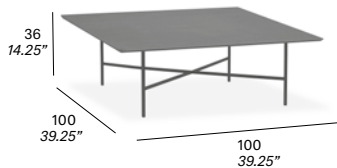

#### frame \*

- 102 FT light grey, 108 FT oxide, 110 FT bronze, 111 FT graphite, 113 FT sage, 120 FT off white, 124 FT linen

#### HPL premium top 13 mm/0.51" 3,846

- 320 silver quartzite, 321 italian slate, 323 natural chalkstone, 327 titanium bronze

#### FENIX NTM® top 12 mm/0.47" 4,428

- 029 bianco male, 720 nero ingo

#### Dekton® top 8 mm/0.31" 5,526

- K1 albarium, K2 argentium, K3 umber, K4 micron
- D2 kelya, D3 danae

#### protective cover +512

21 kg — 28 kg / 0,31 m³ — (HPL top, FENIX top option)

31 kg — 38 kg / 0,31 m³ — (dekton top option)

\* included in price

## Grada outdoor

Manufacturer: Expormim, Spain

REF	ARTICLE	OPTIONS	TOTAL (CAD\$)
-----	---------	---------	---------------

### C914 Rectangular coffee table

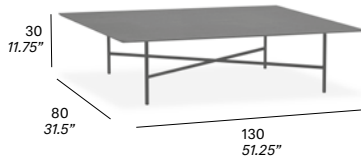

#### frame \*

- 102 FT light grey, 108 FT oxide, 110 FT bronze, 111 FT graphite, 113 FT sage, 120 FT off white, 124 FT linen

#### HPL premium top 13 mm/0.51" 4,065

- 320 silver quartzite, 321 italian slate, 323 natural chalkstone, 327 titanium bronze

#### FENIX NTM® top 12 mm/0.47" 4,527

- 029 bianco male, 720 nero ingo

#### Dekton® top 8 mm/0.31" 5,829

- K1 albarium, K2 argentium, K3 umber, K4 micron
- D2 kelya, D3 danae

#### protective cover +452

22 kg — 42 kg / 0,31 m³ — (HPL top, FENIX top option)

32 kg — 52 kg / 0,31 m³ — (dekton top option)

### C915 Rectangular coffee table

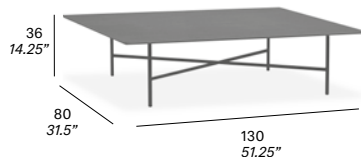

#### frame \*

- 102 FT light grey, 108 FT oxide, 110 FT bronze, 111 FT graphite, 113 FT sage, 120 FT off white, 124 FT linen

#### HPL premium top 13 mm/0.51" 4,146

- 320 silver quartzite, 321 italian slate, 323 natural chalkstone, 327 titanium bronze

#### FENIX NTM® top 12 mm/0.47" 4,608

- 029 bianco male, 720 nero ingo

#### Dekton® top 8 mm/0.31" 5,910

- K1 albarium, K2 argentium, K3 umber, K4 micron
- D2 kelya, D3 danae

#### protective cover +488

22 kg — 42 kg / 0,31 m³ — (HPL top, FENIX top option)

32 kg — 52 kg / 0,31 m³ — (dekton top option)

\* included in price



## Grada outdoor

Manufacturer: Expormim, Spain

REF	ARTICLE	OPTIONS	TOTAL (CAD\$)
-----	---------	---------	---------------

### C916 Round coffee table

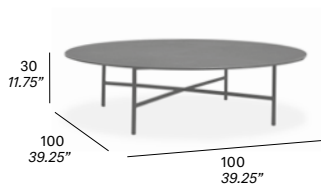

#### frame

- 102 FT light grey, 108 FT oxide, 110 FT bronze, 111 FT graphite, 113 FT sage, 120 FT off white, 124 FT linen

#### HPL premium top 13 mm/0.51"

- 320 silver quartzite, 321 italian slate, 323 natural chalkstone, 327 titanium bronze

3,765

#### FENIX NTM<sup>®</sup> top 12 mm/0.47"

- 029 bianco male, 720 nero ingo

4,326



#### Dekton<sup>®</sup> top 8 mm/0.31"

- K1 albarium, K2 argentium, K3 umber, K4 micron
- D2 kelya, D3 danae

5,778

#### protective cover

+410

 17 kg —  24 kg / 0,22 m<sup>3</sup> — (HPL top, FENIX top option)

 25 kg —  32 kg / 0,22 m<sup>3</sup> — (dekton top option)

### C917 Round coffee table

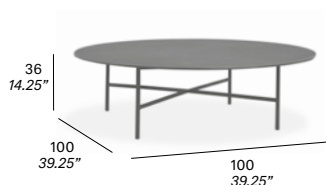

#### frame

\*

- 102 FT light grey, 108 FT oxide, 110 FT bronze, 111 FT graphite, 113 FT sage, 120 FT off white, 124 FT linen

#### HPL premium top 13 mm/0.51"

- 320 silver quartzite, 321 italian slate, 323 natural chalkstone, 327 titanium bronze

3,846

#### FENIX NTM<sup>®</sup> top 12 mm/0.47"

- 029 bianco male, 720 nero ingo

4,407

#### Dekton<sup>®</sup> top 8 mm/0.31"



- K1 albarium, K2 argentium, K3 umber, K4 micron
- D2 kelya, D3 danae

5,859

#### protective cover

+464

 17 kg —  24 kg / 0,22 m<sup>3</sup> — (HPL top, FENIX top option)

 25 kg —  32 kg / 0,22 m<sup>3</sup> — (dekton top option)

\* included in price

## Grada outdoor

Manufacturer: Expormim, Spain

REF	ARTICLE	OPTIONS	TOTAL (CAD\$)
-----	---------	---------	---------------

### C907 Round coffee table

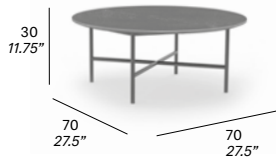

<b>frame</b>	*
<ul style="list-style-type: none"> <li>102 FT light grey, 108 FT oxide, 110 FT bronze, 111 FT graphite, 113 FT sage, 120 FT off white, 124 FT linen</li> </ul>	
<b>HPL premium top 13 mm/0.51"</b>	2,154
<ul style="list-style-type: none"> <li>320 silver quartzite, 321 italian slate, 323 natural chalkstone, 327 titanium bronze</li> </ul>	
<b>FENIX NTM* top 12 mm/0.47"</b>	2,478
<ul style="list-style-type: none"> <li>029 bianco male, 720 nero ingo</li> </ul>	
<b>Dekton* top 8 mm/0.31"</b>	3,639
<ul style="list-style-type: none"> <li>K1 albarium, K2 argentium, K3 umber, K4 micron</li> <li>D2 kelya, D3 danae</li> </ul>	
<b>protective cover</b>	+402

8 kg — 12 kg / 0,13 m<sup>3</sup> — (HPL top, FENIX top option)  
 12 kg — 16 kg / 0,13 m<sup>3</sup> — (dekton top option)

### C919 Side table

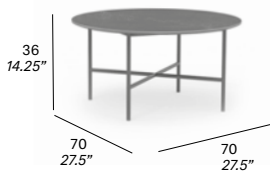

<b>frame</b>	*
<ul style="list-style-type: none"> <li>102 FT light grey, 108 FT oxide, 110 FT bronze, 111 FT graphite, 113 FT sage, 120 FT off white, 124 FT linen</li> </ul>	
<b>HPL premium top 13 mm/0.51"</b>	2,256
<ul style="list-style-type: none"> <li>320 silver quartzite, 321 italian slate, 323 natural chalkstone, 327 titanium bronze</li> </ul>	
<b>FENIX NTM* top 12 mm/0.47"</b>	2,577
<ul style="list-style-type: none"> <li>029 bianco male, 720 nero ingo</li> </ul>	
<b>Dekton* top 8 mm/0.31"</b>	3,681
<ul style="list-style-type: none"> <li>K1 albarium, K2 argentium, K3 umber, K4 micron</li> <li>D2 kelya, D3 danae</li> </ul>	
<b>protective cover</b>	+438

8 kg — 12 kg / 0,13 m<sup>3</sup> — (HPL top, FENIX top option)  
 12 kg — 16 kg / 0,13 m<sup>3</sup> — (dekton top option)

## Grada outdoor

Manufacturer: Expormim, Spain

REF      ARTICLE      OPTIONS      TOTAL (CAD\$)

### C941 Round coffee table

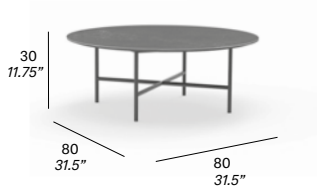

**frame** \*

- 102 FT light grey, 108 FT oxide, 110 FT bronze, 111 FT graphite, 113 FT sage, 120 FT off white, 124 FT linen

**HPL premium top 13 mm/0.51"** 2,481

- 320 silver quartzite, 321 italian slate, 323 natural chalkstone, 327 titanium bronze

**FENIX NTM® top 12 mm/0.47"** 2,871

- 029 bianco male, 720 nero ingo

**Dekton® top 8 mm/0.31"** 4,194

- K1 albarium, K2 argentium, K3 umber, K4 micron
- D2 kelya, D3 danae

**protective cover** +402

10 kg — 14 kg / 0,14 m³ — (HPL top, FENIX top option)

15 kg — 19 kg / 0,14 m³ — (dekton top option)

### C942 Side table

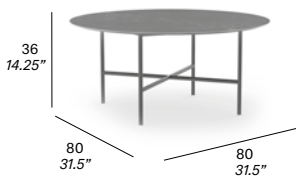

**frame** \*

- 102 FT light grey, 108 FT oxide, 110 FT bronze, 111 FT graphite, 113 FT sage, 120 FT off white, 124 FT linen

**HPL premium top 13 mm/0.51"** 2,547

- 320 silver quartzite, 321 italian slate, 323 natural chalkstone, 327 titanium bronze

**FENIX NTM® top 12 mm/0.47"** 2,919

- 029 bianco male, 720 nero ingo

**Dekton® top 8 mm/0.31"** 4,251

- K1 albarium, K2 argentium, K3 umber, K4 micron
- D2 kelya, D3 danae

**protective cover** +438

10 kg — 14 kg / 0,14 m³ — (HPL top, FENIX top option)

15 kg — 19 kg / 0,14 m³ — (dekton top option)

\* included in price

## Grada outdoor

Manufacturer: Expormim, Spain

REF      ARTICLE      OPTIONS      TOTAL (CAD\$)

### C951    Elliptical coffee table

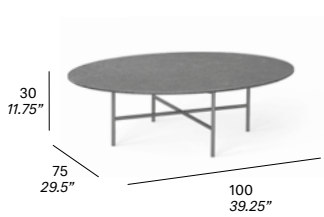

#### frame

- 102 FT light grey, 108 FT oxide, 110 FT bronze, 111 FT graphite, 113 FT sage, 120 FT off white, 124 FT linen

#### HPL premium top 13 mm/0.51"

2,340

- 320 silver quartzite, 321 italian slate, 323 natural chalkstone, 327 titanium bronze

#### FENIX NTM<sup>®</sup> top 12 mm/0.47"

2,718

- 029 bianco male, 720 nero ingo

#### Dekton<sup>®</sup> top 8 mm/0.31"

4,176

- K1 albarium, K2 argentium, K3 umber, K4 micron
- D2 kelya, D3 danae

#### protective cover

+ 476

- 12 kg — 16 kg / 0,16 m<sup>3</sup> — (HPL top, FENIX top option)
- 18 kg — 21 kg / 0,16 m<sup>3</sup> — (dekton top option)

### C952    Elliptical coffee table

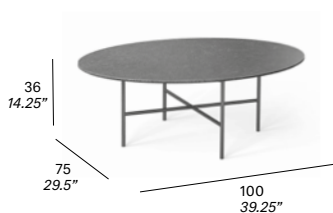

#### frame

\*

- 102 FT light grey, 108 FT oxide, 110 FT bronze, 111 FT graphite, 113 FT sage, 120 FT off white, 124 FT linen

#### HPL premium top 13 mm/0.51"

2,421

- 320 silver quartzite, 321 italian slate, 323 natural chalkstone, 327 titanium bronze

#### FENIX NTM<sup>®</sup> top 12 mm/0.47"

2,799

- 029 bianco male, 720 nero ingo

#### Dekton<sup>®</sup> top 8 mm/0.31"

4,257

- K1 albarium, K2 argentium, K3 umber, K4 micron
- D2 kelya, D3 danae

#### protective cover

+476

- 12 kg — 16 kg / 0,16 m<sup>3</sup> — (HPL top, FENIX top option)
- 18 kg — 21 kg / 0,16 m<sup>3</sup> — (dekton top option)

\* included in price

## Grada outdoor

Manufacturer: Expormim, Spain

REF      ARTICLE      OPTIONS      TOTAL (CAD\$)

### C953      Elliptical coffee table

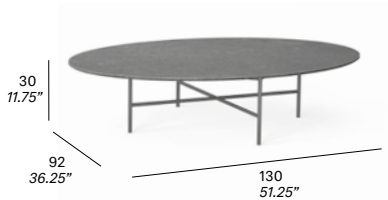

#### frame \*

- 102 FT light grey, 108 FT oxide, 110 FT bronze, 111 FT graphite, 113 FT sage, 120 FT off white, 124 FT linen

#### HPL premium top 13 mm/0.51" 3,513

- 320 silver quartzite, 321 italian slate, 323 natural chalkstone, 327 titanium bronze

#### FENIX NTM\* top 12 mm/0.47" 4,086

- 029 bianco male, 720 nero ingo

#### Dekton\* top 8 mm/0.31" 5,991

- K1 albarium, K2 argentium, K3 umber, K4 micron
- D2 kelya, D3 danae

#### protective cover +484

20 kg — 27 kg / 0,24 m<sup>3</sup> — (HPL top, FENIX top option)

29 kg — 36 kg / 0,24 m<sup>3</sup> — (dekton top option)

### C954      Elliptical coffee table

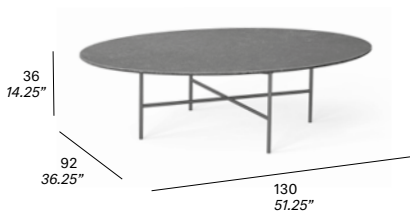

#### frame \*

- 102 FT light grey, 108 FT oxide, 110 FT bronze, 111 FT graphite, 113 FT sage, 120 FT off white, 124 FT linen

#### HPL premium top 13 mm/0.51" 3,594

- 320 silver quartzite, 321 italian slate, 323 natural chalkstone, 327 titanium bronze

#### FENIX NTM\* top 12 mm/0.47" 4,167

- 029 bianco male, 720 nero ingo

#### Dekton\* top 8 mm/0.31" 6,072

- K1 albarium, K2 argentium, K3 umber, K4 micron
- D2 kelya, D3 danae

#### protective cover +484

20 kg — 27 kg / 0,26 m<sup>3</sup> — (HPL top, FENIX top option)

29 kg — 36 kg / 0,26 m<sup>3</sup> — (dekton top option)

## Grada outdoor

Manufacturer: Expormim, Spain

REF      ARTICLE      OPTIONS      TOTAL (CAD\$)

### C955 Elliptical coffee table

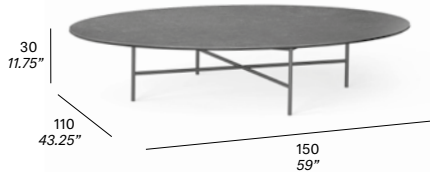

#### frame

\*

- 102 FT light grey, 108 FT oxide, 110 FT bronze, 111 FT graphite, 113 FT sage, 120 FT off white, 124 FT linen

#### HPL premium top 13 mm/0.51"

4,419

- 320 silver quartzite, 321 italian slate, 323 natural chalkstone, 327 titanium bronze

#### FENIX NTM® top 12 mm/0.47"

5,226

- 029 bianco male, 720 nero ingo

#### Dekton® top 8 mm/0.31"

7,395

- K1 albarium, K2 argentium, K3 umber, K4 micron
- D2 kelya, D3 danae

#### protective cover

+536

- 27 kg — 35 kg / 0,35 m<sup>3</sup> — (HPL top, FENIX top option)
- 39 kg — 48 kg / 0,35 m<sup>3</sup> — (dekton top option)

### C956 Elliptical coffee table

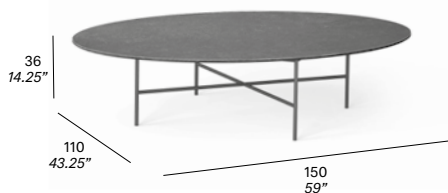

#### frame

\*

- 102 FT light grey, 108 FT oxide, 110 FT bronze, 111 FT graphite, 113 FT sage, 120 FT off white, 124 FT linen

#### HPL premium top 13 mm/0.51"

4,530

- 320 silver quartzite, 321 italian slate, 323 natural chalkstone, 327 titanium bronze

#### FENIX NTM® top 12 mm/0.47"

5,337

- 029 bianco male, 720 nero ingo

#### Dekton® top 8 mm/0.31"

7,506

- K1 albarium, K2 argentium, K3 umber, K4 micron
- D2 kelya, D3 danae

#### protective cover





+536

- 27 kg — 35 kg / 0,37 m<sup>3</sup> — (HPL top, FENIX top option)
- 39 kg — 48 kg / 0,37 m<sup>3</sup> — (dekton top option)

\* included in price

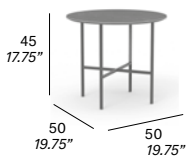
## Grada outdoor

Manufacturer: Expormim, Spain

REF	ARTICLE	OPTIONS	TOTAL (CAD\$)
C910	Side table		
			
		<b>frame</b> *	
		<ul style="list-style-type: none"> <li>102 FT light grey, 108 FT oxide, 110 FT bronze, 111 FT graphite, 113 FT sage, 120 FT off white, 124 FT linen</li> </ul>	
		<b>HPL premium top 13 mm/0.51"</b>	1,614
		<ul style="list-style-type: none"> <li>320 silver quartzite, 321 italian slate, 323 natural chalkstone, 327 titanium bronze</li> </ul>	
		<b>FENIX NTM® top 12 mm/0.47"</b>	1,797
		<ul style="list-style-type: none"> <li>029 bianco male, 720 nero ingo</li> </ul>	
		<b>Dekton® top 8 mm/0.31"</b>	2,730
		<ul style="list-style-type: none"> <li>K1 albarium, K2 argentium, K3 umber, K4 micron</li> <li>D2 kelya, D3 danae</li> </ul>	
		<b>protective cover</b>	+356
		<ul style="list-style-type: none"> <li> 5 kg —  7 kg / 0,15 m² — (HPL top, FENIX top option)</li> <li> 7 kg —  10 kg / 0,08 m² — (dekton top option)</li> </ul>	



**Tusch Seating International Inc.**  
251 Bartley Dr. Unit #4  
Toronto, ON M4A 2N7 Canada  
www.tuschseating.com

T 416.368.6100  
F 416.368.4477  
T 888.368.6101  
info@tuschseating.com